



# Advanced Topics in Information Theory

Lecture Notes

Stefan M. Moser

© Copyright Stefan M. Moser

Signal and Information Processing Lab  
ETH Zurich  
Zurich, Switzerland

Institute of Communications Engineering  
National Yang Ming Chiao Tung University (NYCU)  
Hsinchu, Taiwan

You are welcome to use these lecture notes for yourself, for teaching, or for any other noncommercial purpose. If you use extracts from these lecture notes, please make sure to show their origin. The author assumes no liability or responsibility for any errors or omissions.

5<sup>th</sup> Edition — 2022.

Version 5.7.

Compiled on 10 July 2024.

For the latest version see <https://moser-isi.ethz.ch/scripts.html>

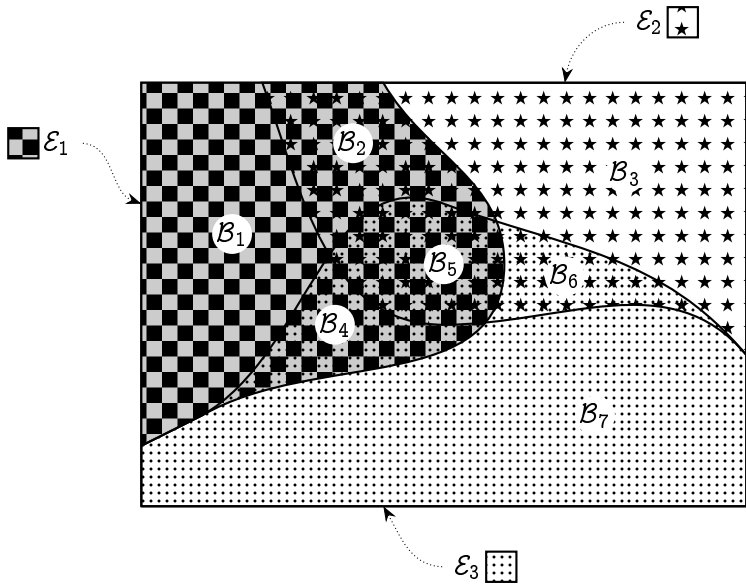

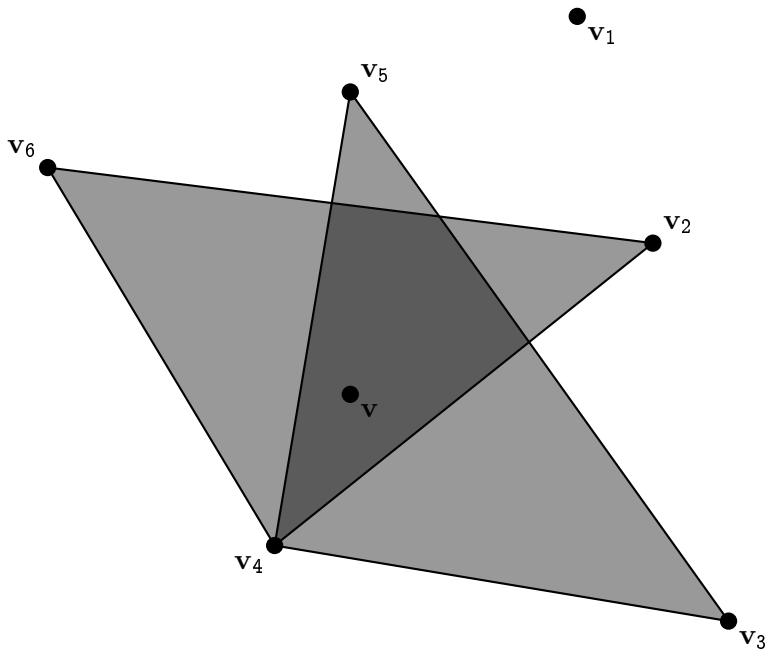

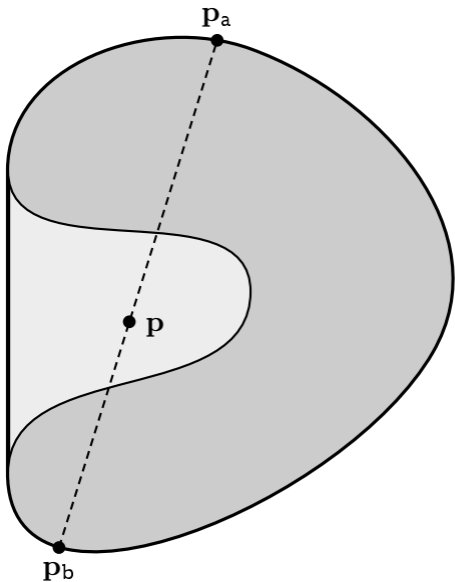

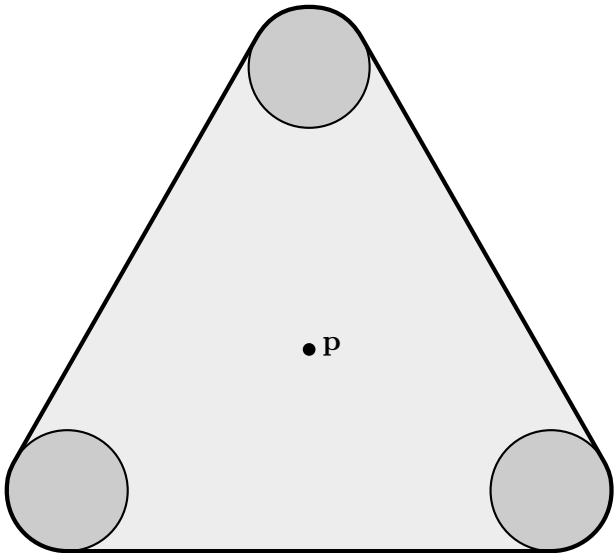

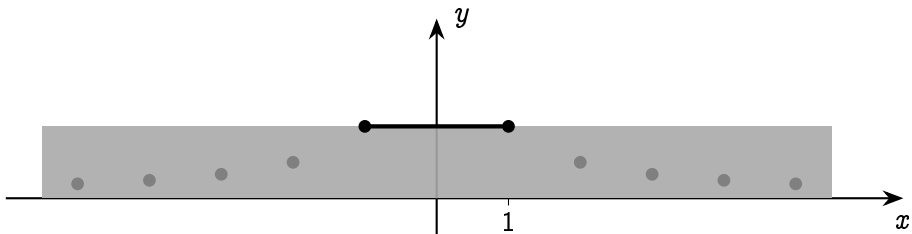
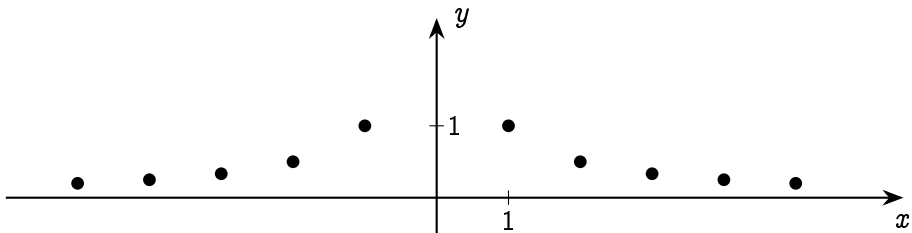

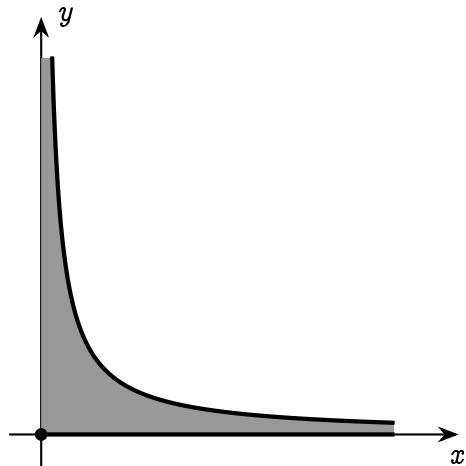
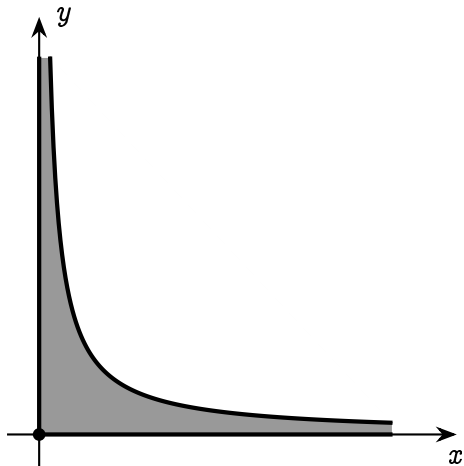

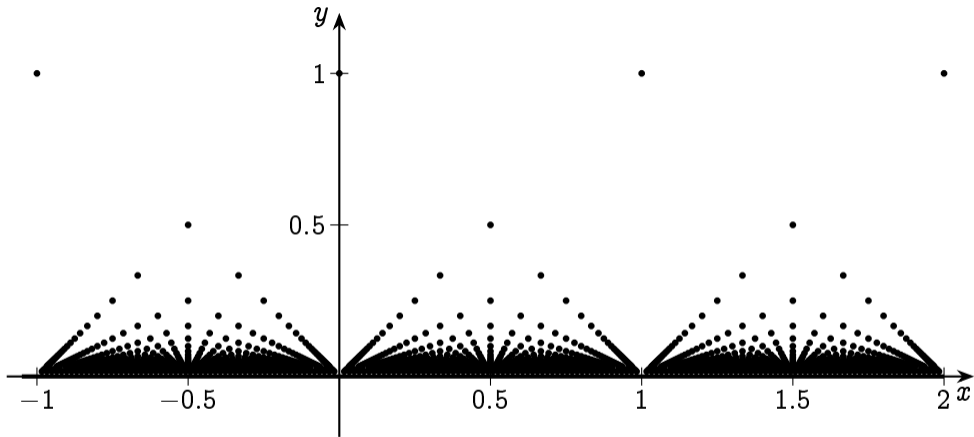



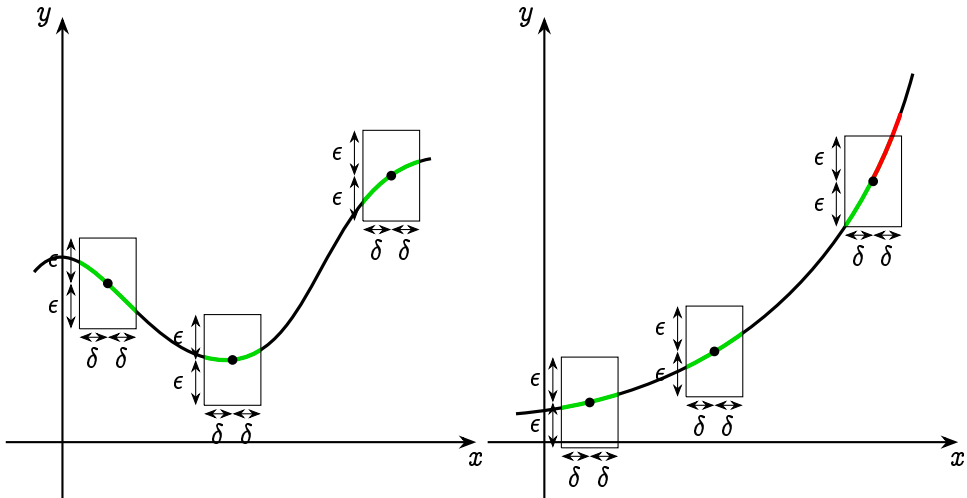

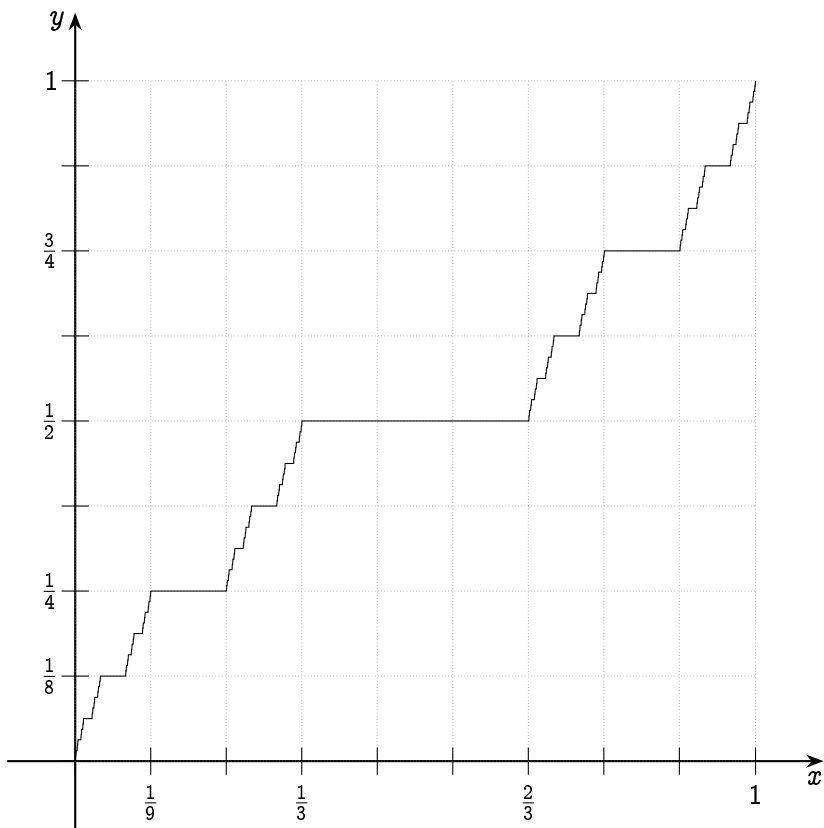

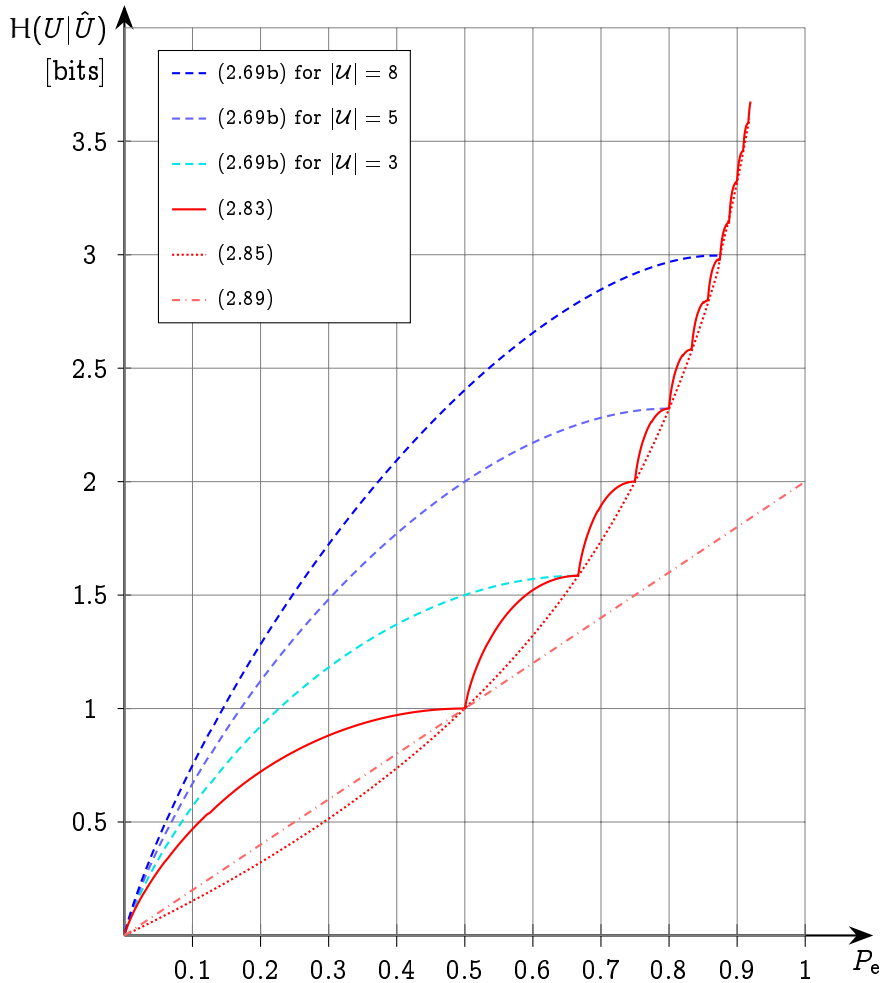

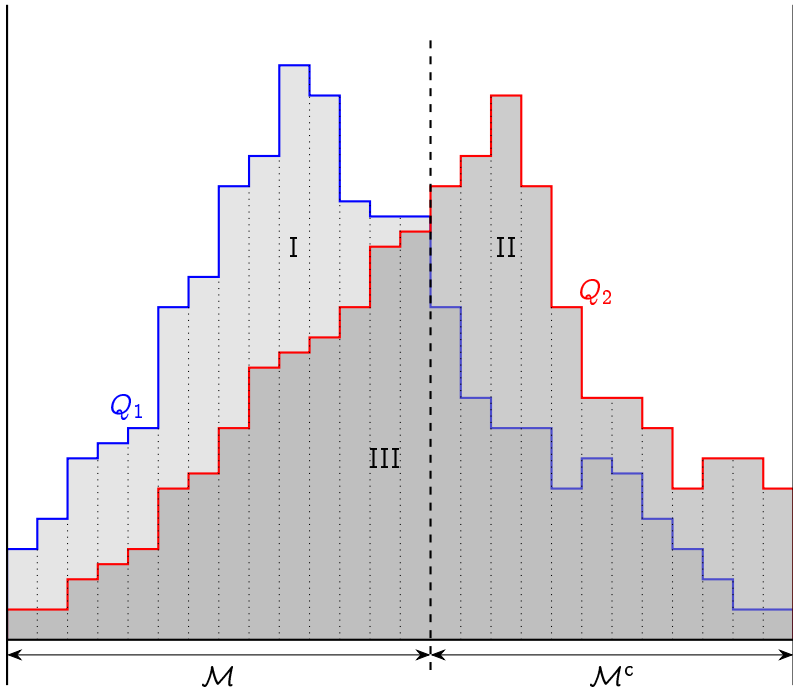

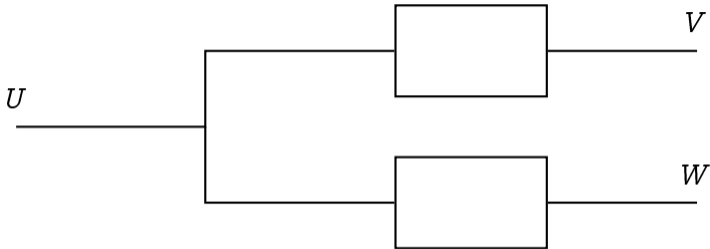

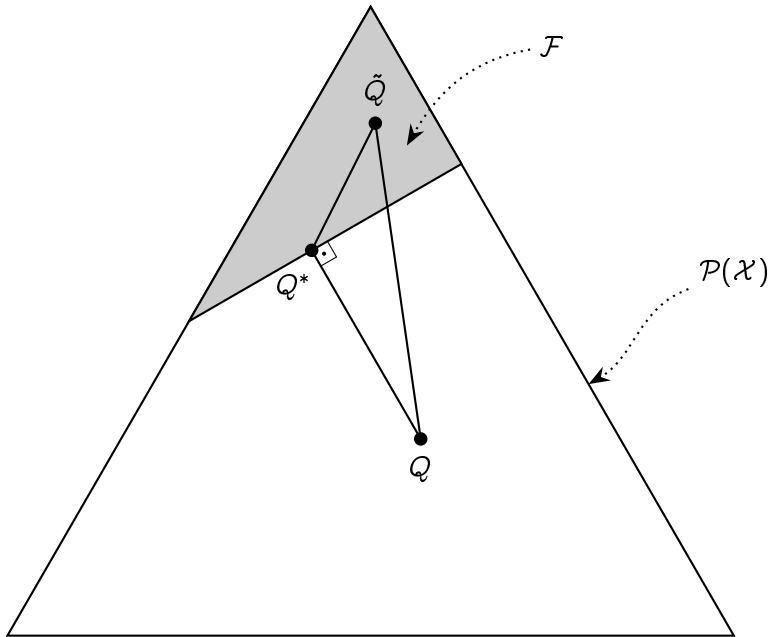

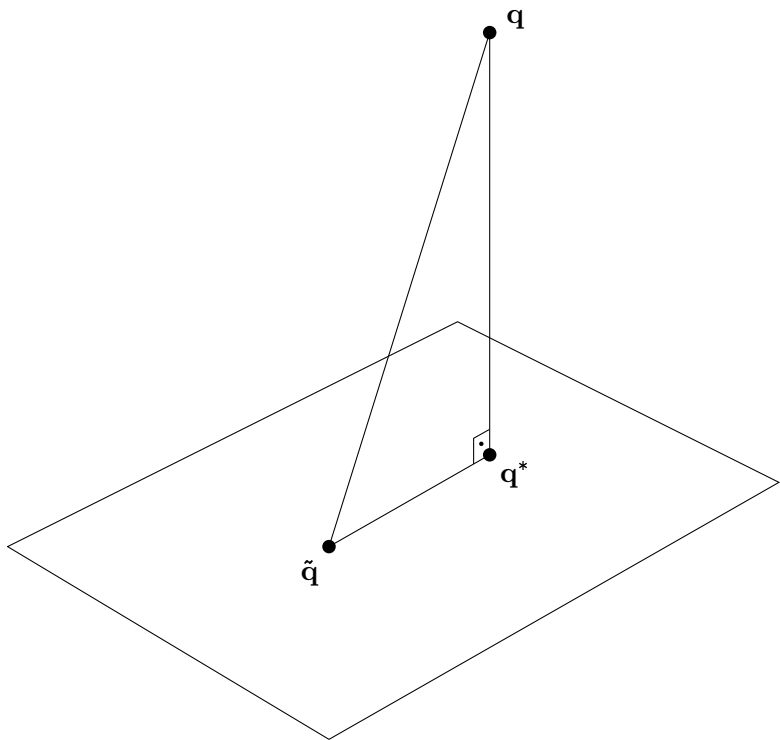

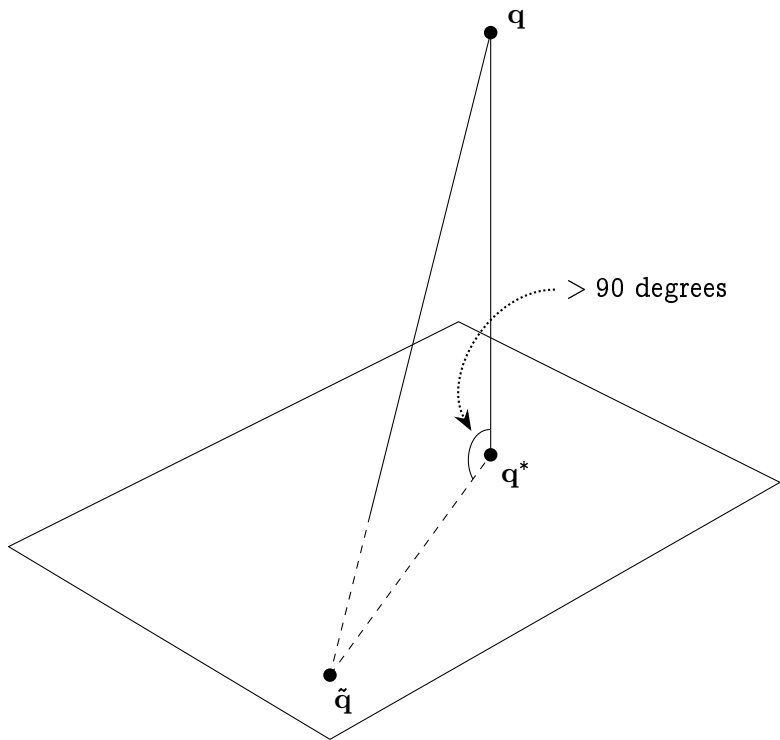



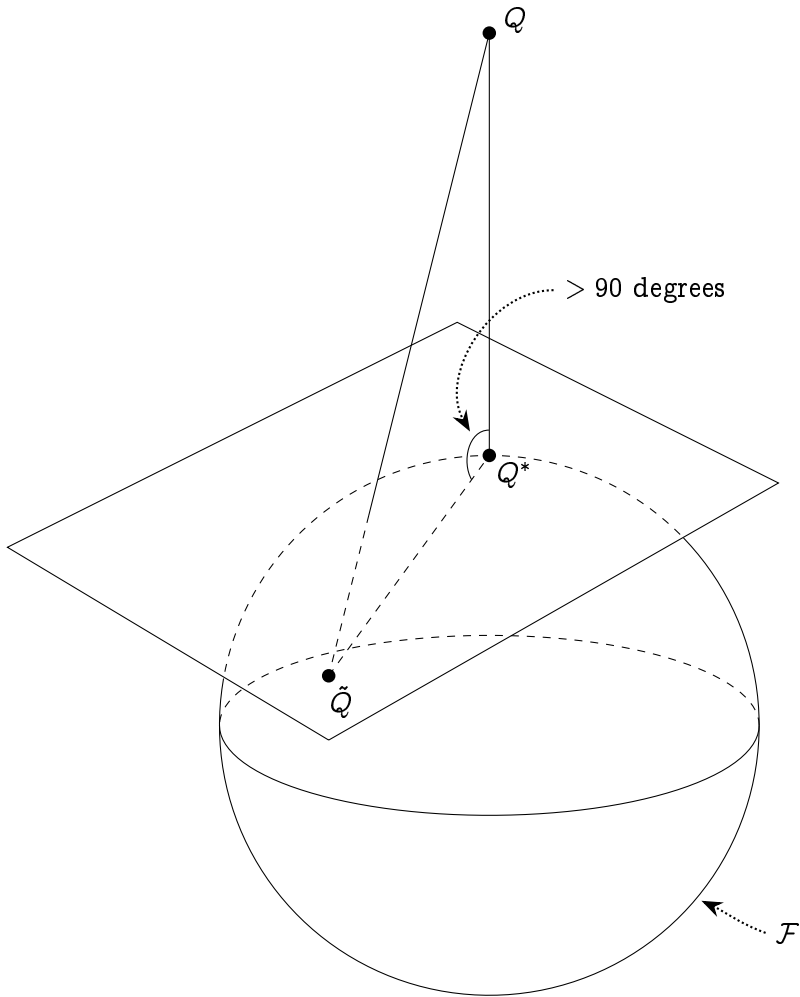

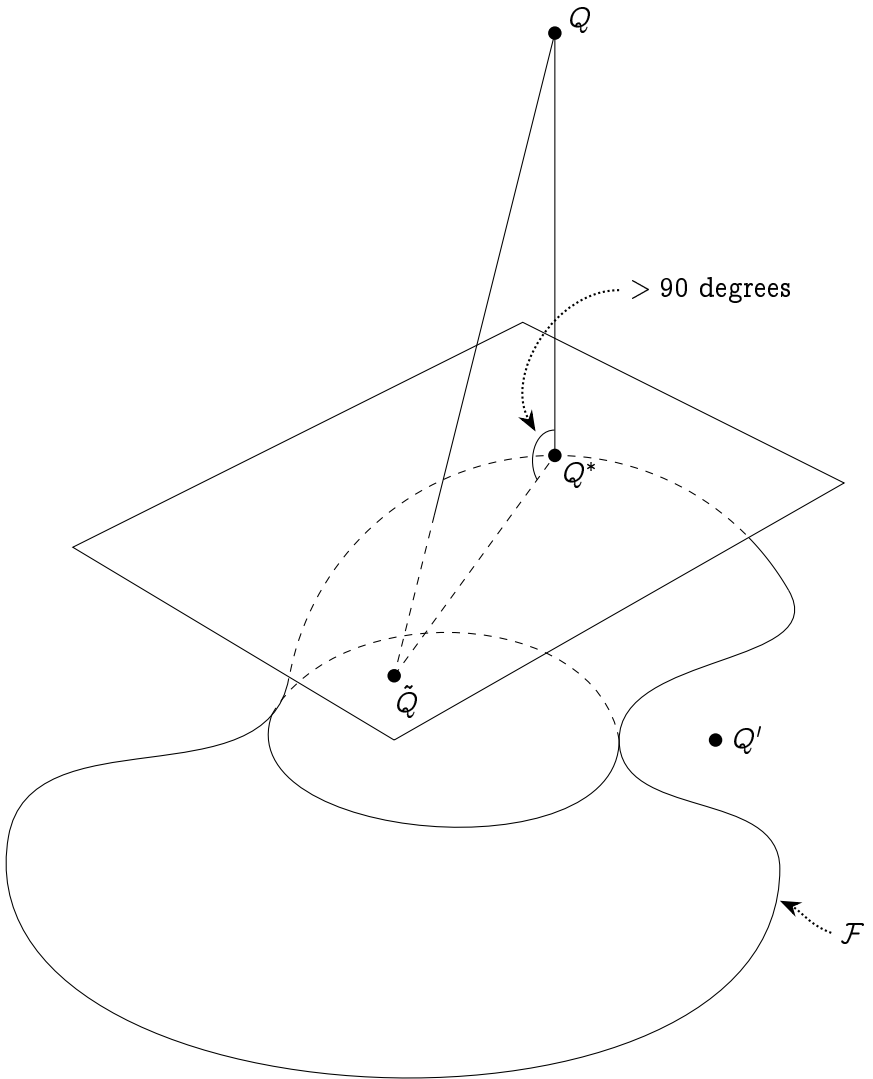

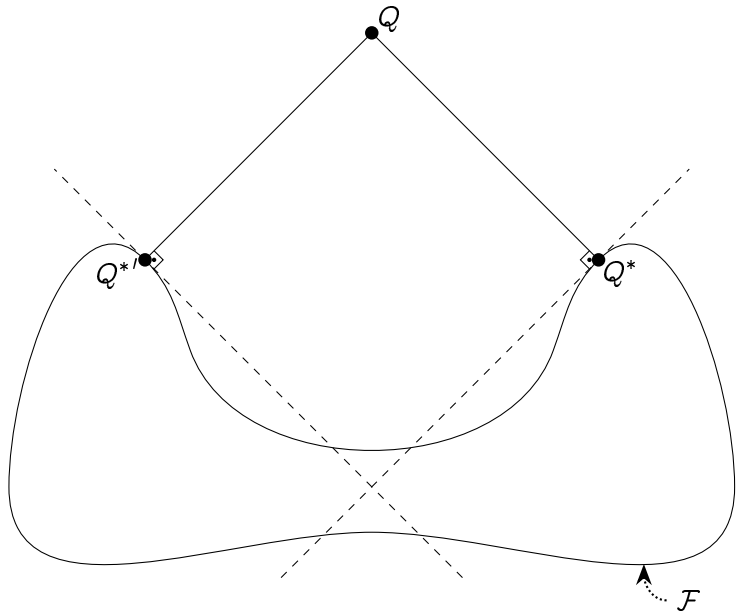

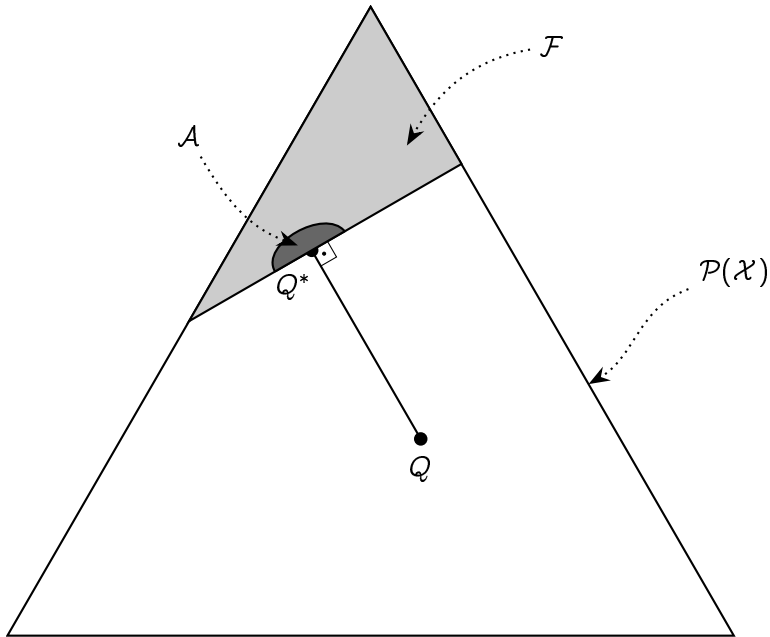

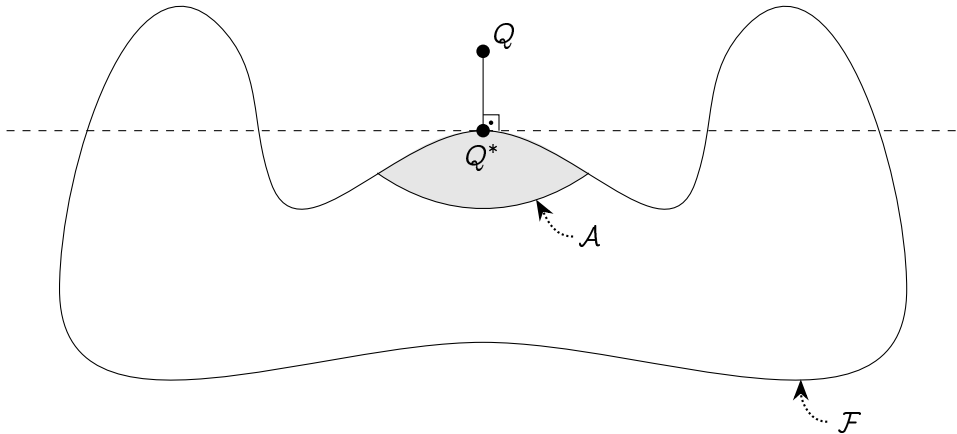

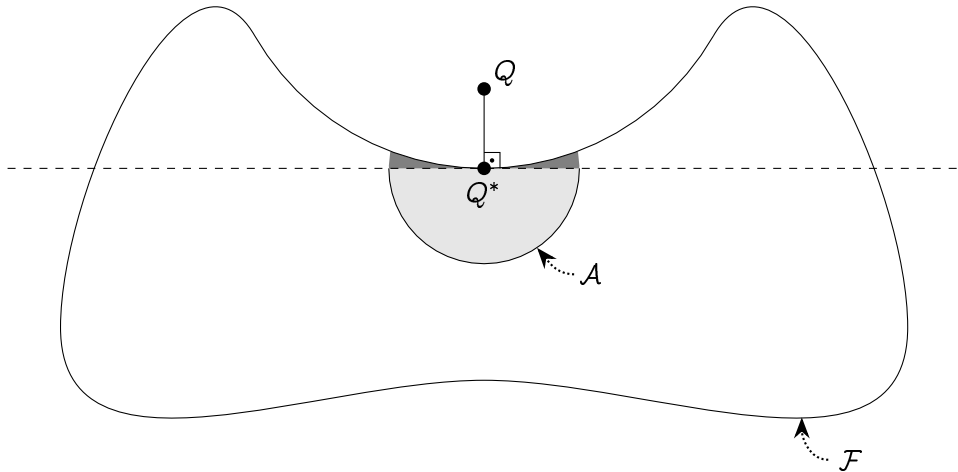

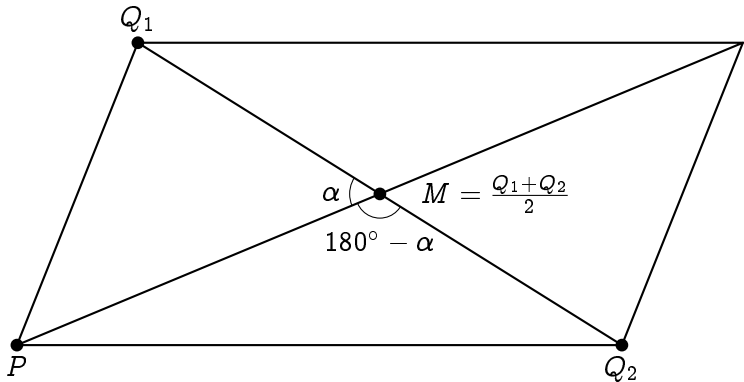

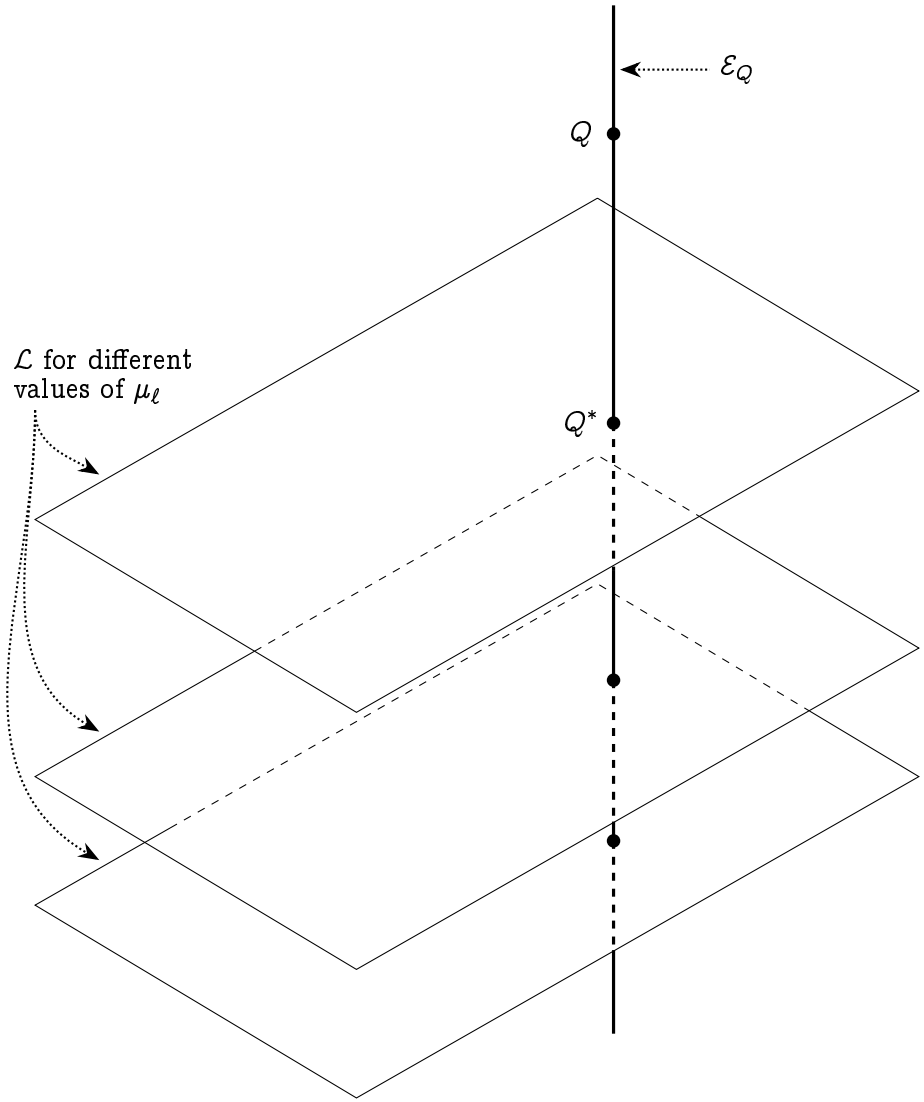



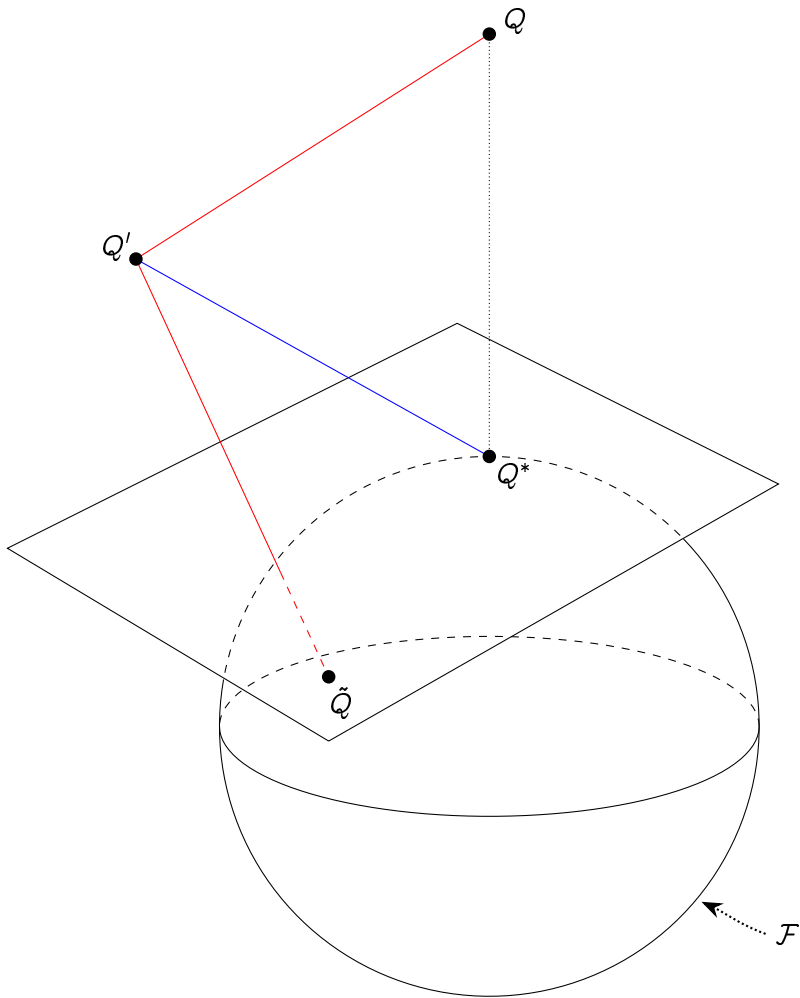

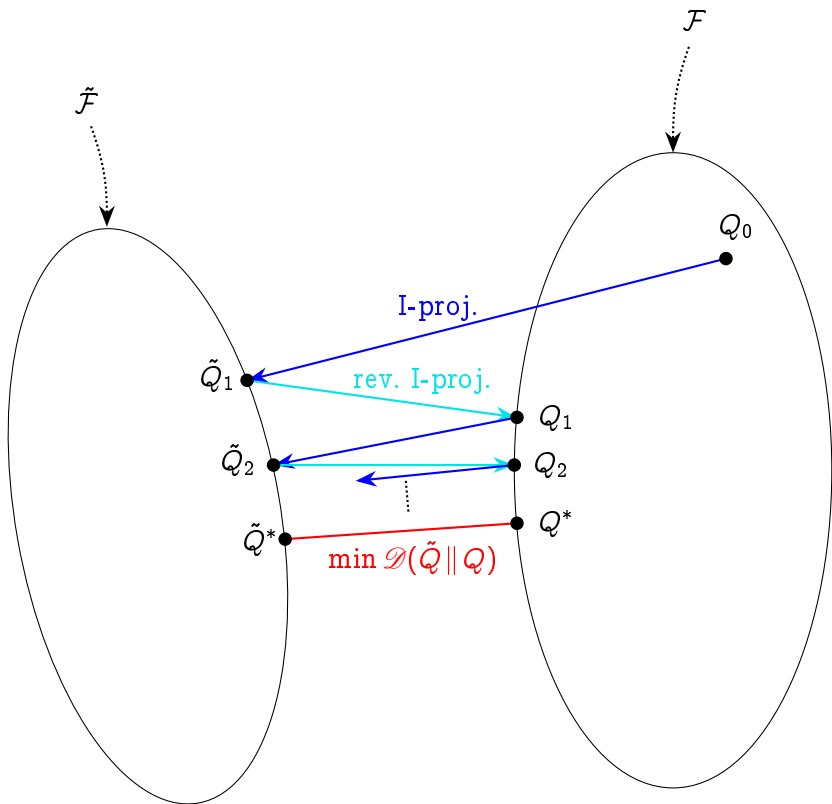

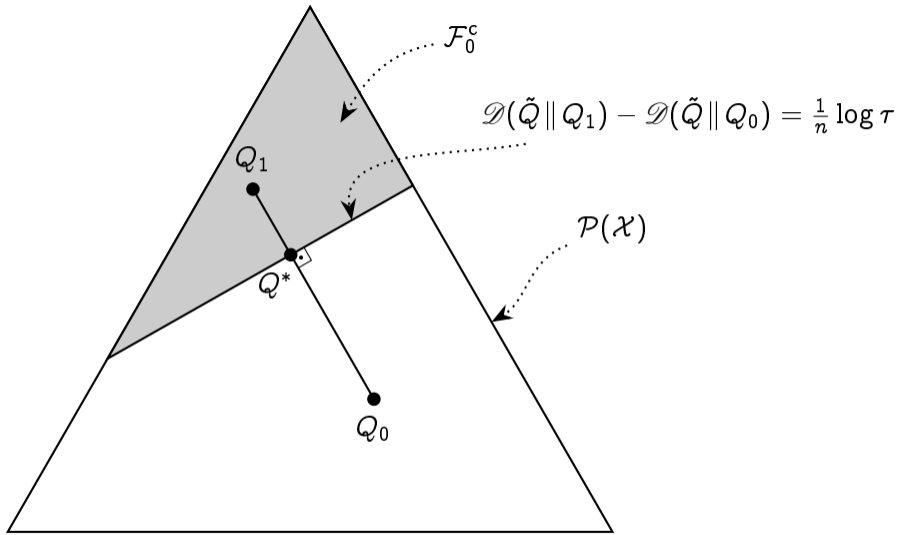

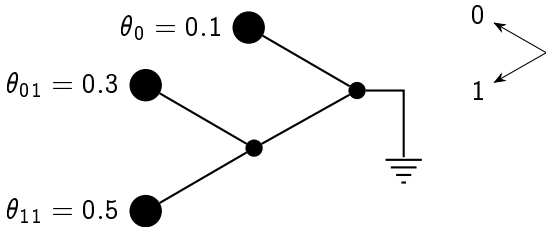

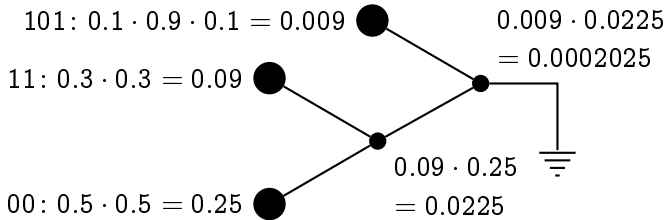

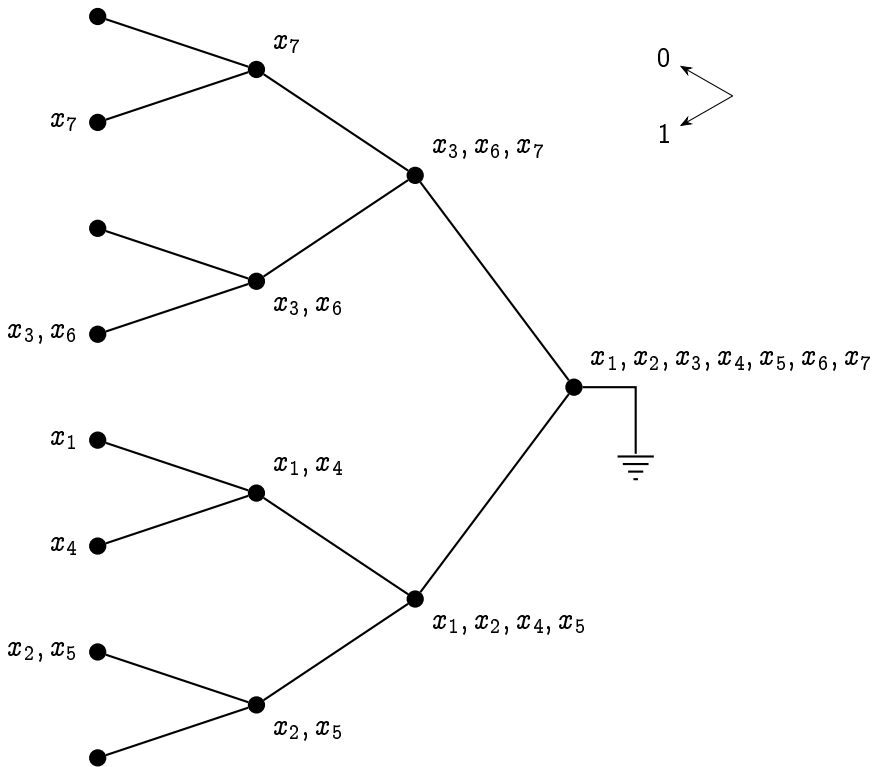

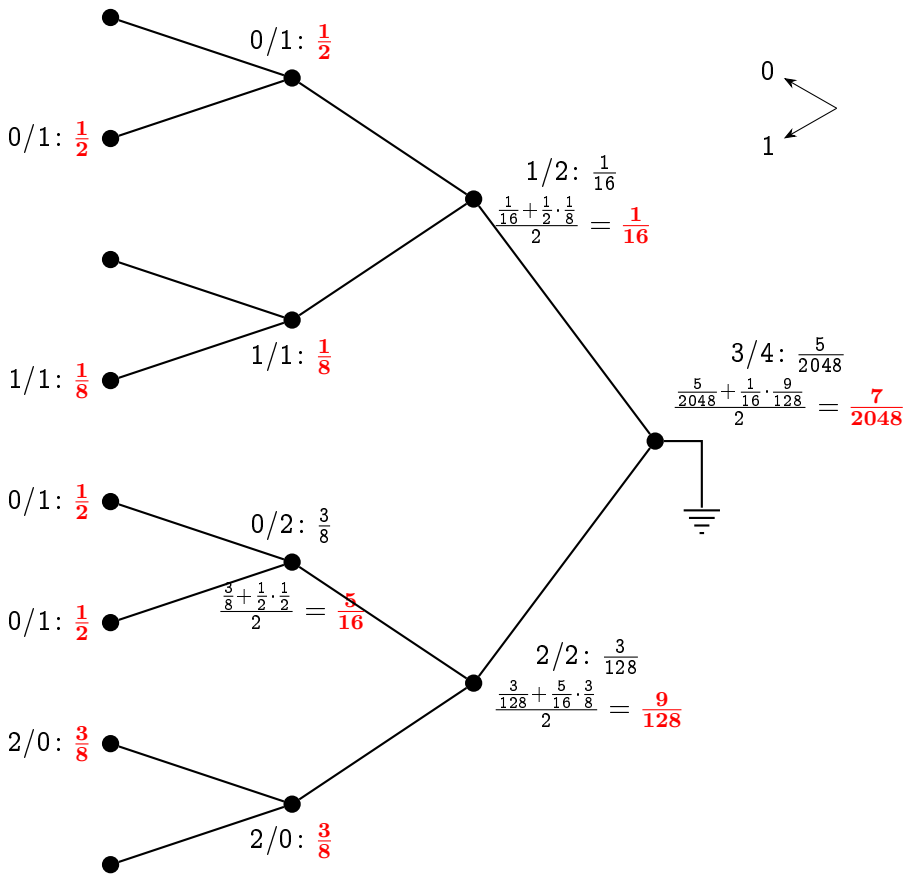

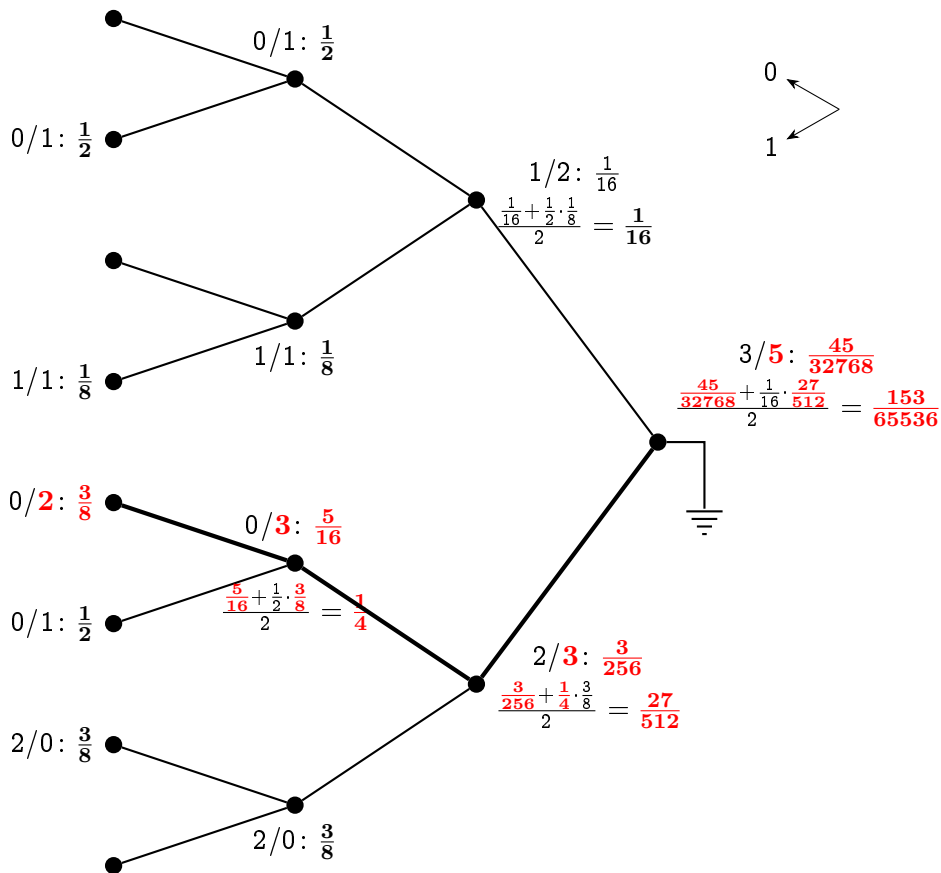



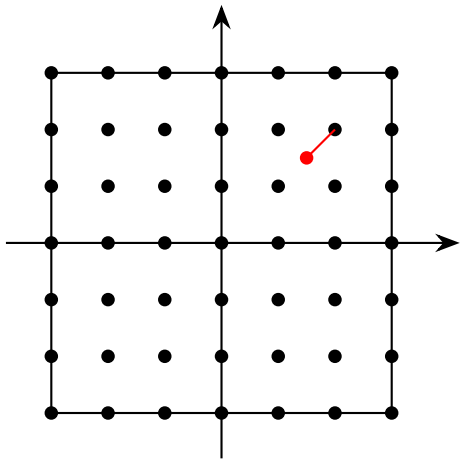

independent description  
49 points

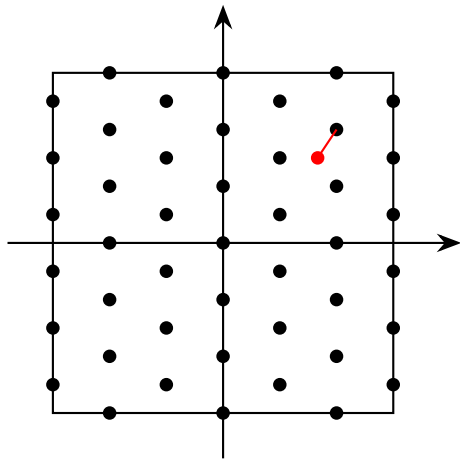

dependent description  
45 points

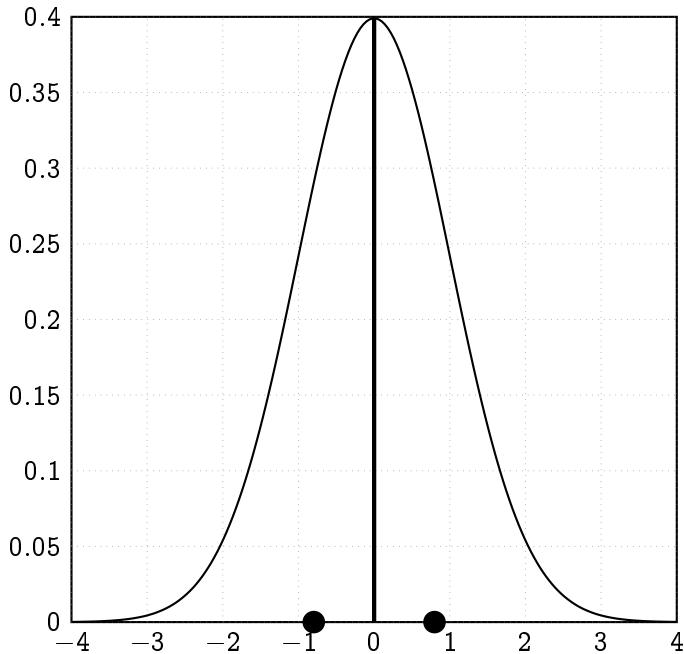

---

$\hat{x}_1$	$\hat{x}_2$	$\theta$
0.5	1	0.75
0.3578	1.3288	0.8433
0.3973	1.4011	0.8992
0.4202	1.4450	0.9326
0.4336	1.4714	0.9525
0.4414	1.4872	0.9643
0.4461	1.4966	0.9714
0.4488	1.5022	0.9755
⋮		
0.4528	1.5104	0.9816

---

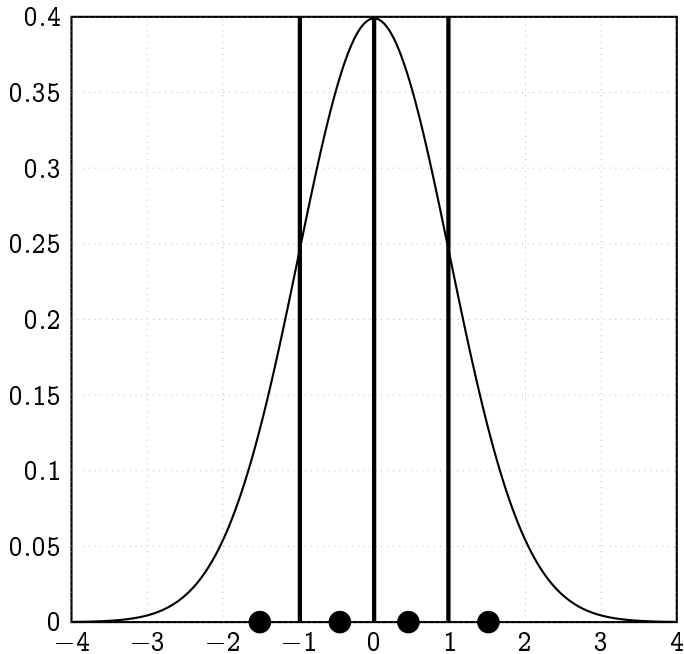

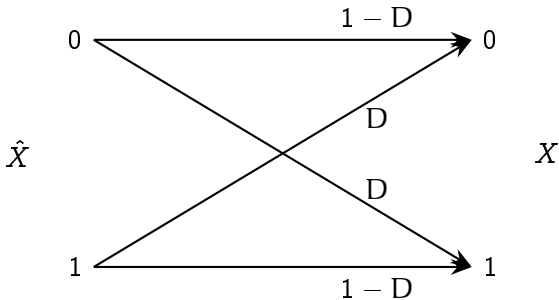

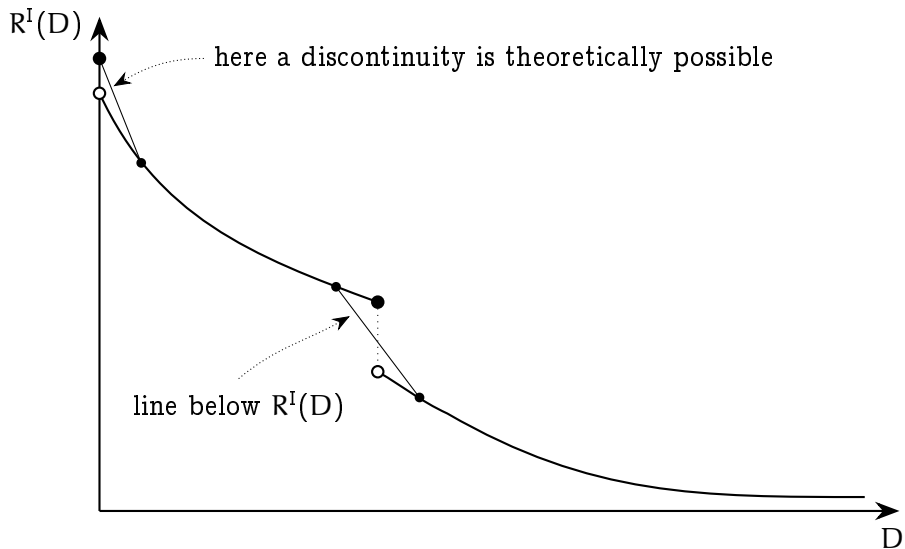

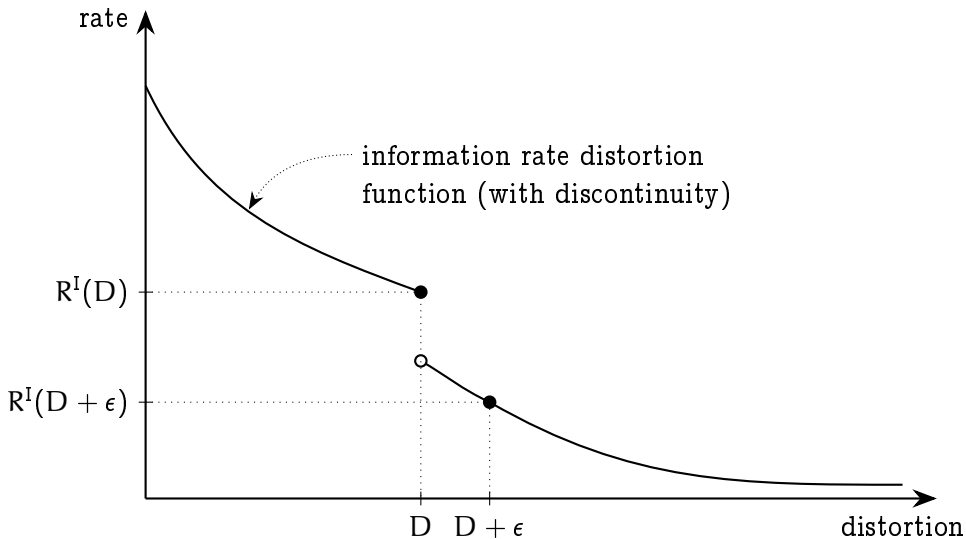

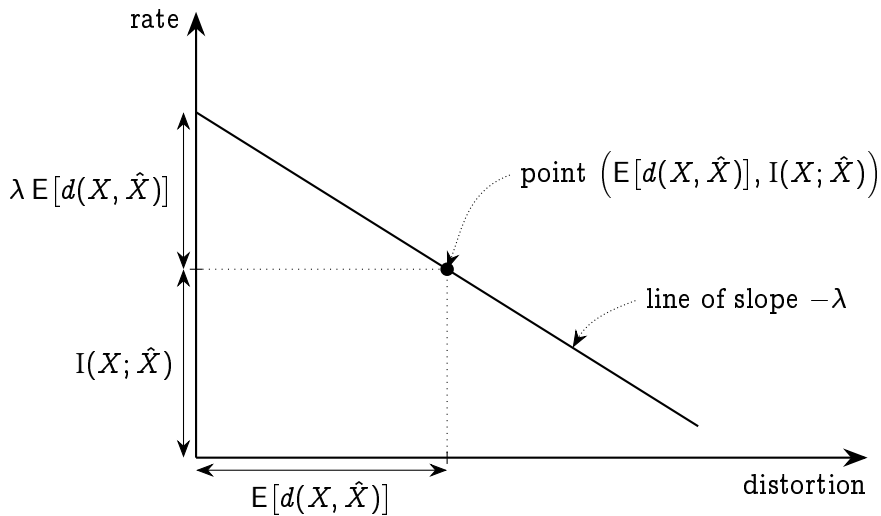



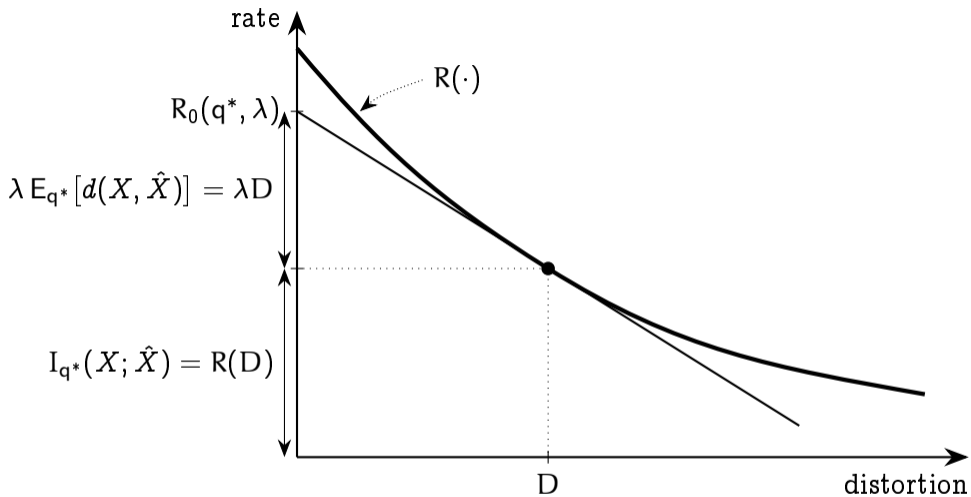

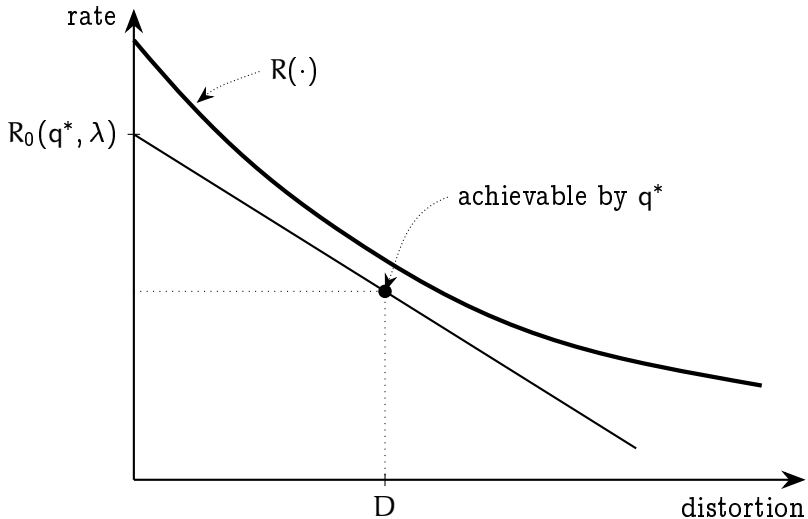

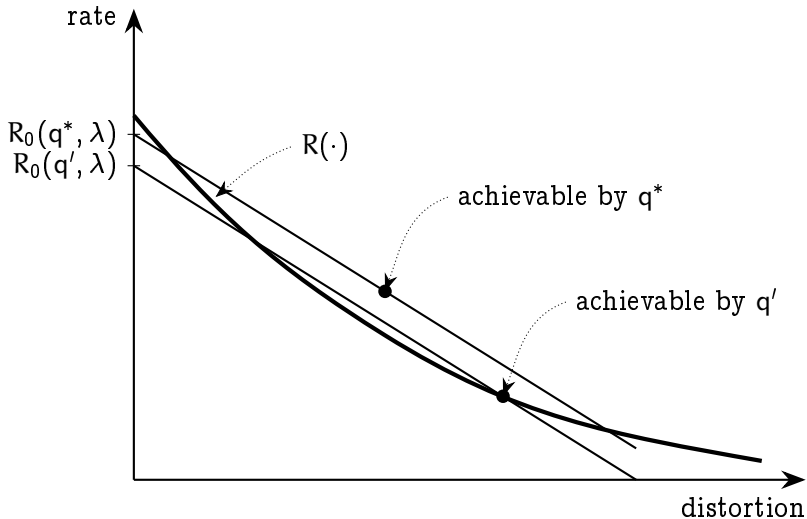

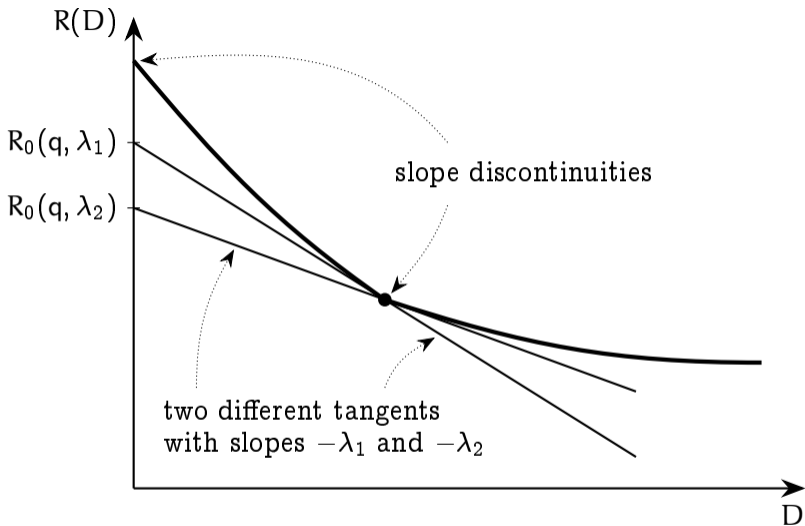

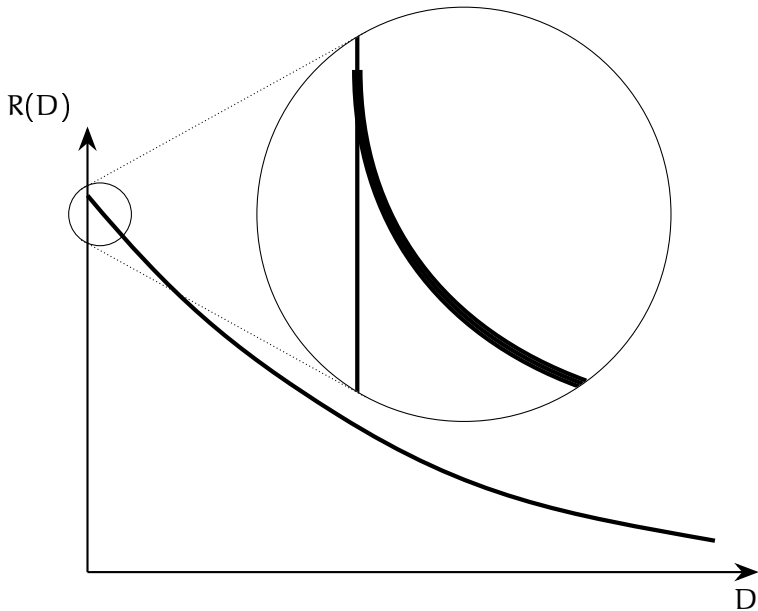



Stefan M. Moser, *Advanced Topics in Information Theory*, Version 5.7.

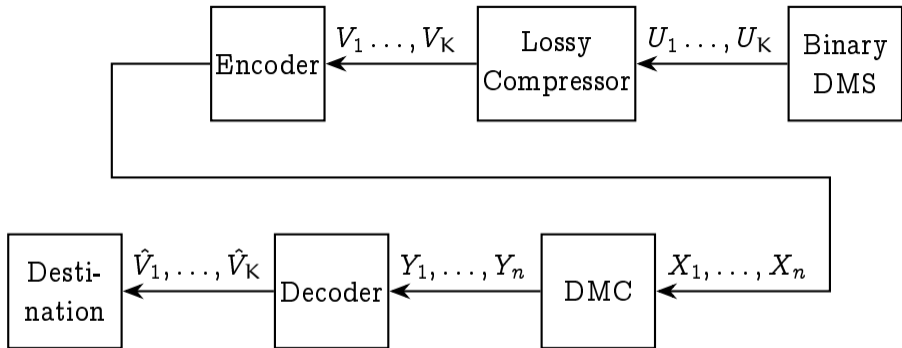

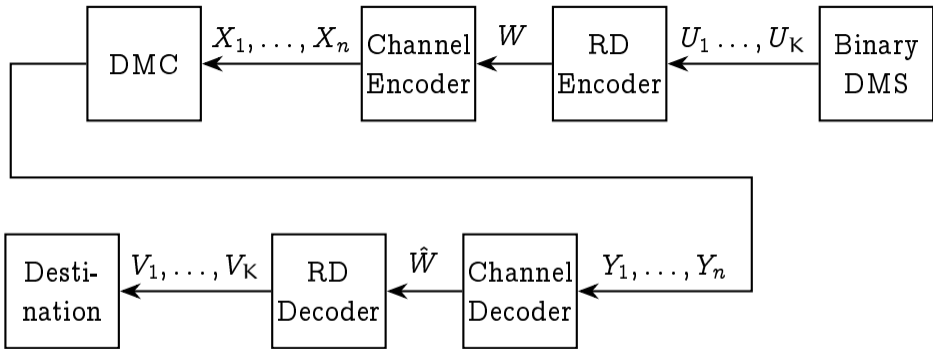



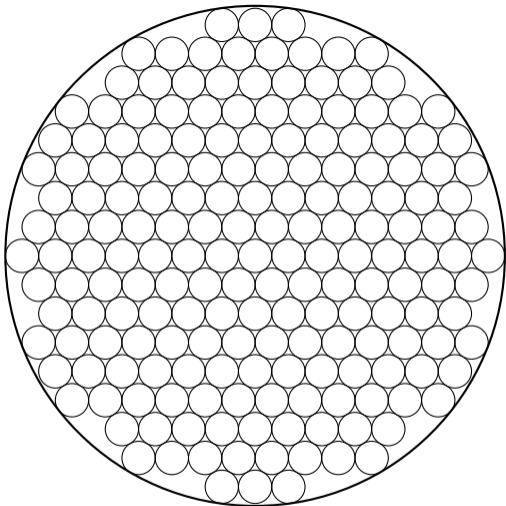

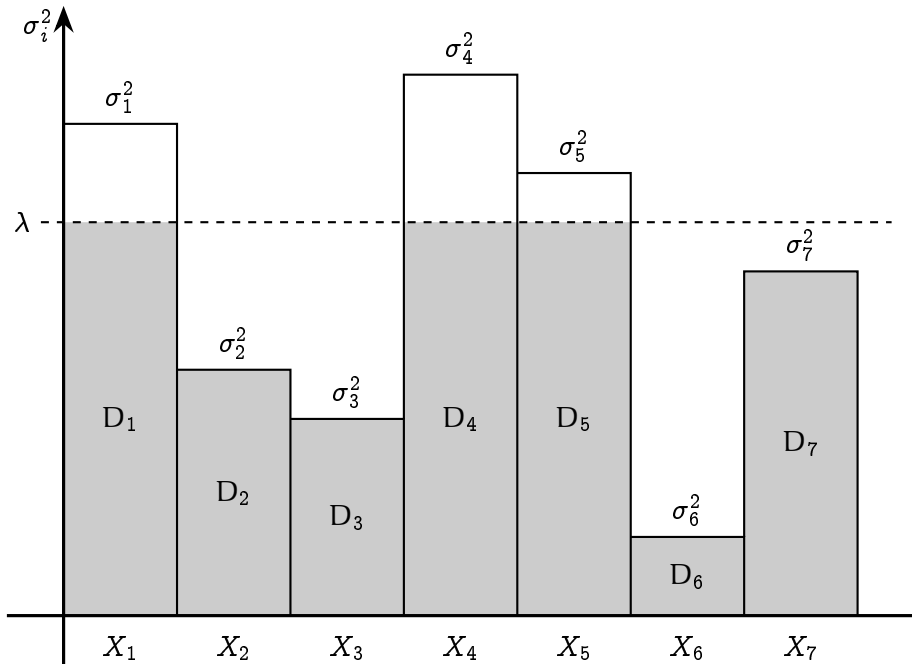

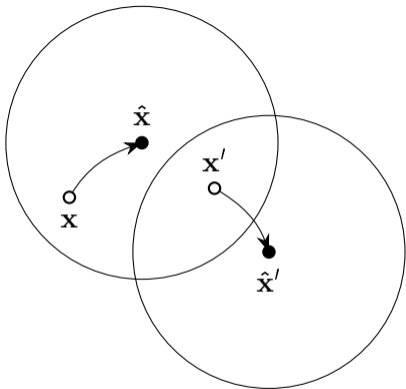

the sources  $\tilde{Q}$  that do not work because for the given  $R$  and  $D$ :

$$R(\tilde{Q}, D) > R$$

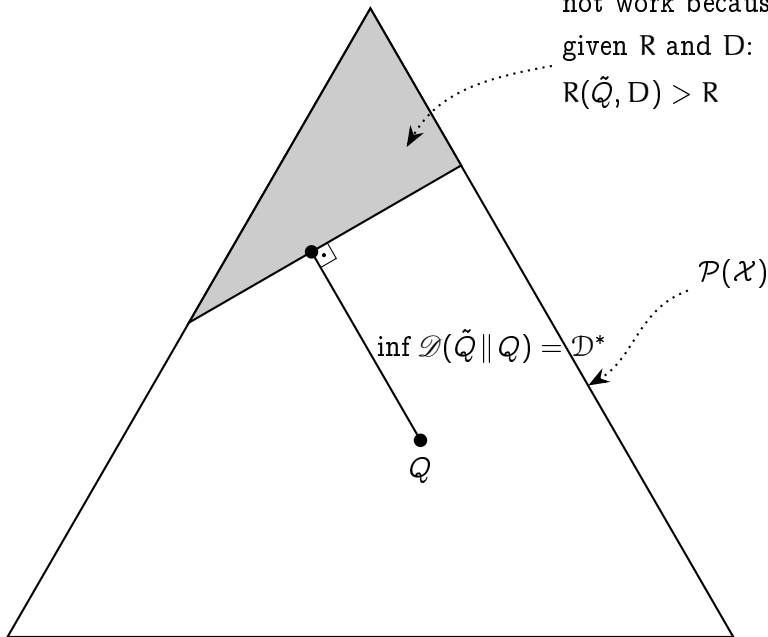

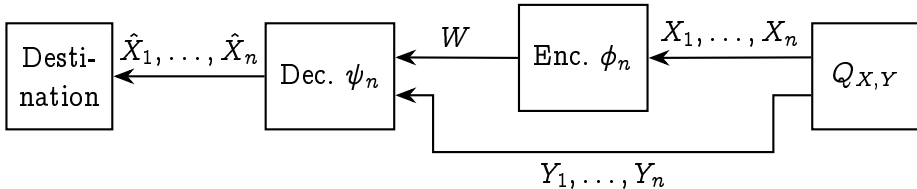

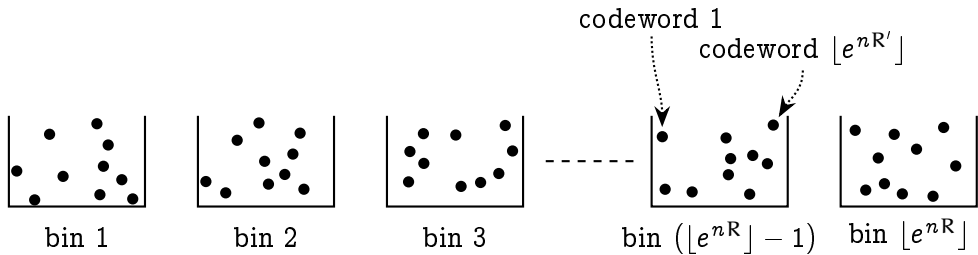

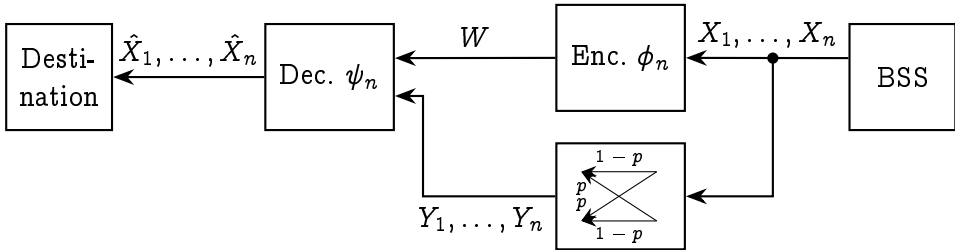

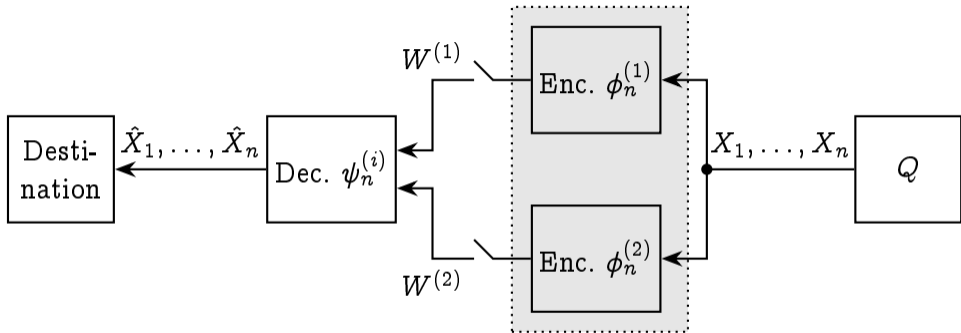



$Q_{\hat{X}^{(1)}, \hat{X}^{(2)} X}(\cdot, \cdot 0)$	$\hat{X}^{(2)} = 0$	$\hat{X}^{(2)} = 1$	$Q_{\hat{X}^{(1)} X}(\cdot 0)$
$\hat{X}^{(1)} = 0$	$3 - 2\sqrt{2}$	$\sqrt{2} - 1$	$2 - \sqrt{2}$
$\hat{X}^{(1)} = 1$	$\sqrt{2} - 1$	0	$\sqrt{2} - 1$
$Q_{\hat{X}^{(2)} X}(\cdot 0)$	$2 - \sqrt{2}$	$\sqrt{2} - 1$	
$Q_{\hat{X}^{(1)}, \hat{X}^{(2)} X}(\cdot, \cdot 1)$	$\hat{X}^{(2)} = 0$	$\hat{X}^{(2)} = 1$	$Q_{\hat{X}^{(1)} X}(\cdot 1)$
$\hat{X}^{(1)} = 0$	0	0	0
$\hat{X}^{(1)} = 1$	0	1	1
$Q_{\hat{X}^{(2)} X}(\cdot 1)$	0	1	

$Q_{\hat{X}^{(1)}, \hat{X}^{(2)}}(\cdot, \cdot)$	$\hat{X}^{(2)} = 0$	$\hat{X}^{(2)} = 1$	$Q_{\hat{X}^{(1)}}(\cdot)$
$\hat{X}^{(1)} = 0$	$\frac{3}{2} - \sqrt{2}$	$\frac{\sqrt{2}}{2} - \frac{1}{2}$	$1 - \frac{\sqrt{2}}{2}$
$\hat{X}^{(1)} = 1$	$\frac{\sqrt{2}}{2} - \frac{1}{2}$	$\frac{1}{2}$	$\frac{\sqrt{2}}{2}$
$Q_{\hat{X}^{(2)}}(\cdot)$	$1 - \frac{\sqrt{2}}{2}$	$\frac{\sqrt{2}}{2}$	

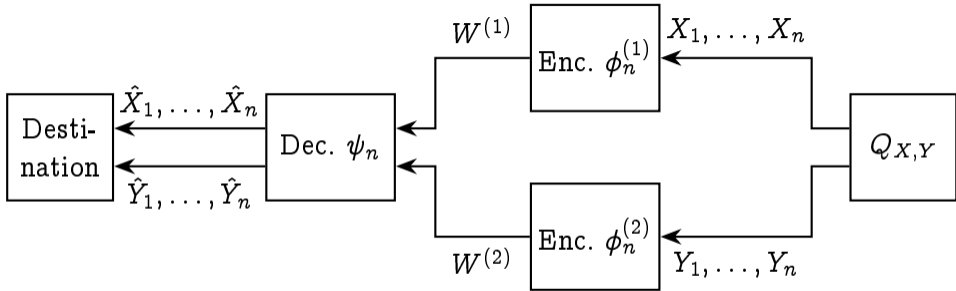

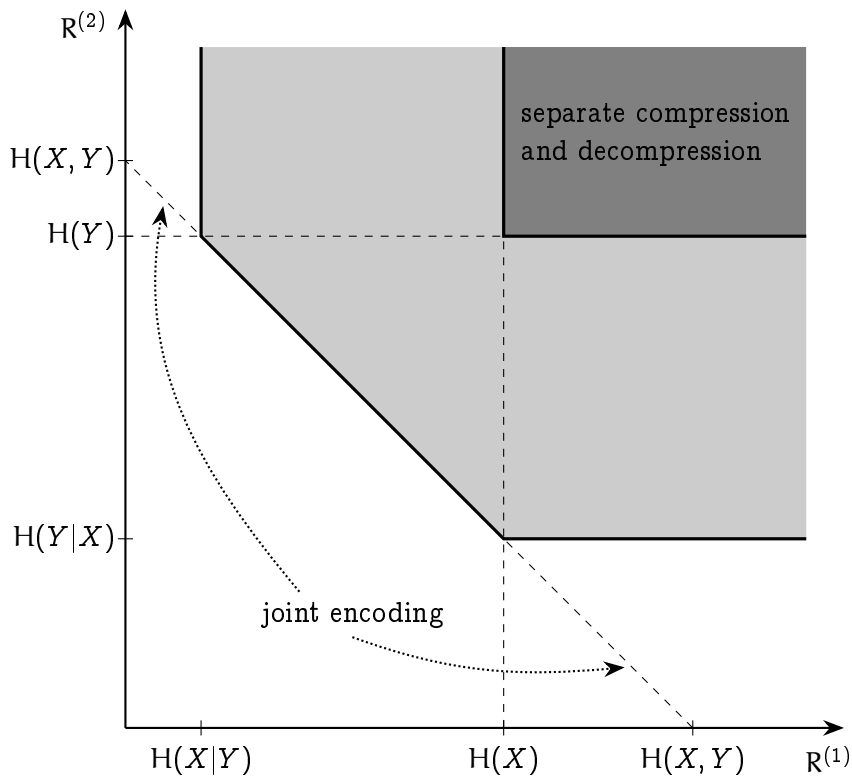

---

$Q_{X,Y}(\cdot, \cdot)$		Taichung $Y$		
		rain	sun	Hsinchu total
Hsinchu $X$	rain	0.445	0.055	0.5
	sun	0.055	0.445	0.5
Taichung total		0.5	0.5	

---

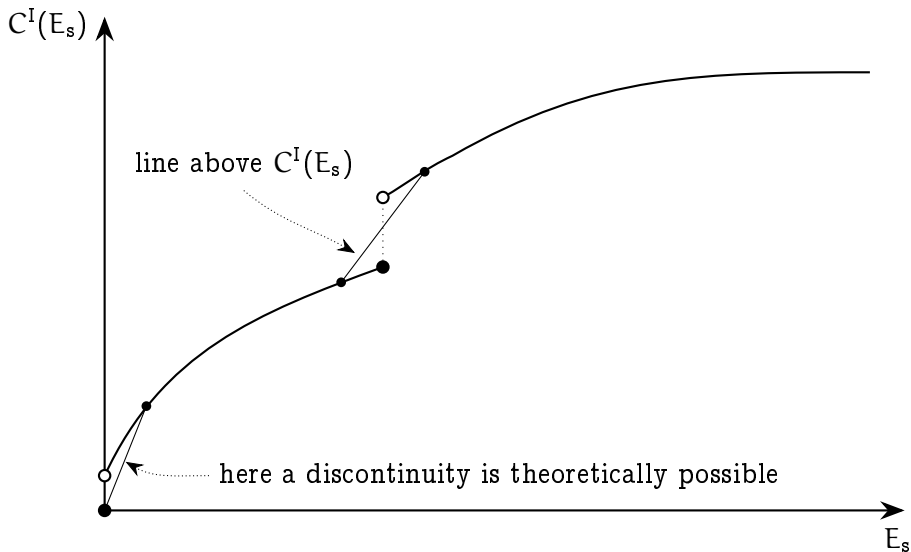

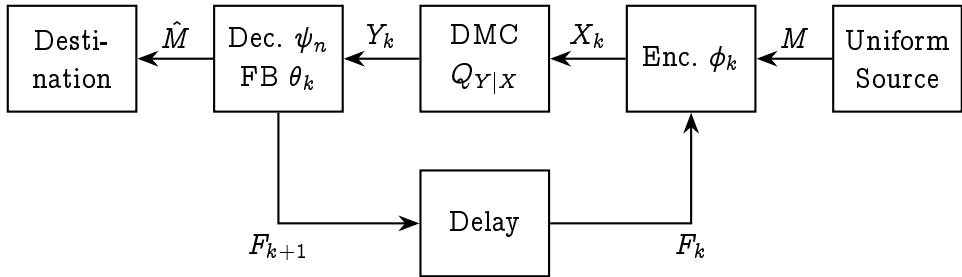

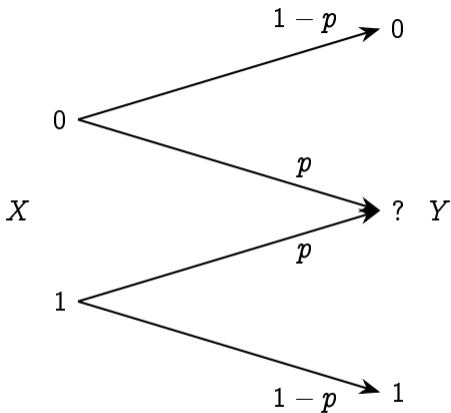



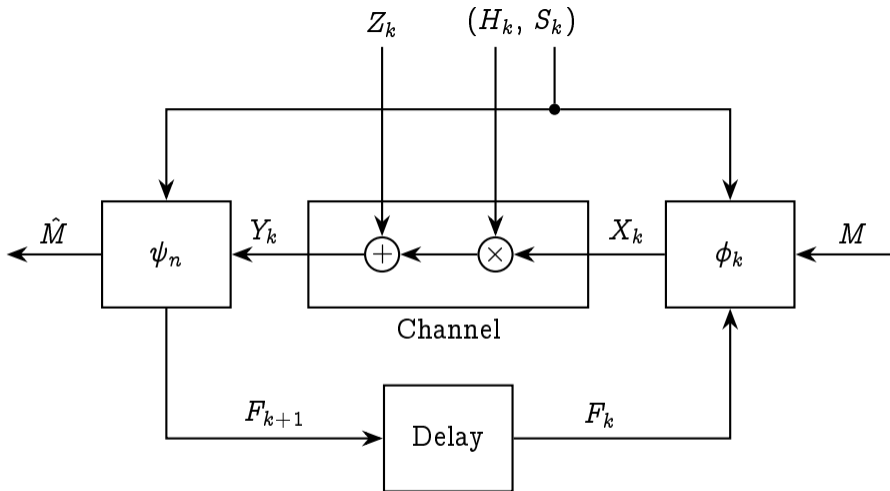

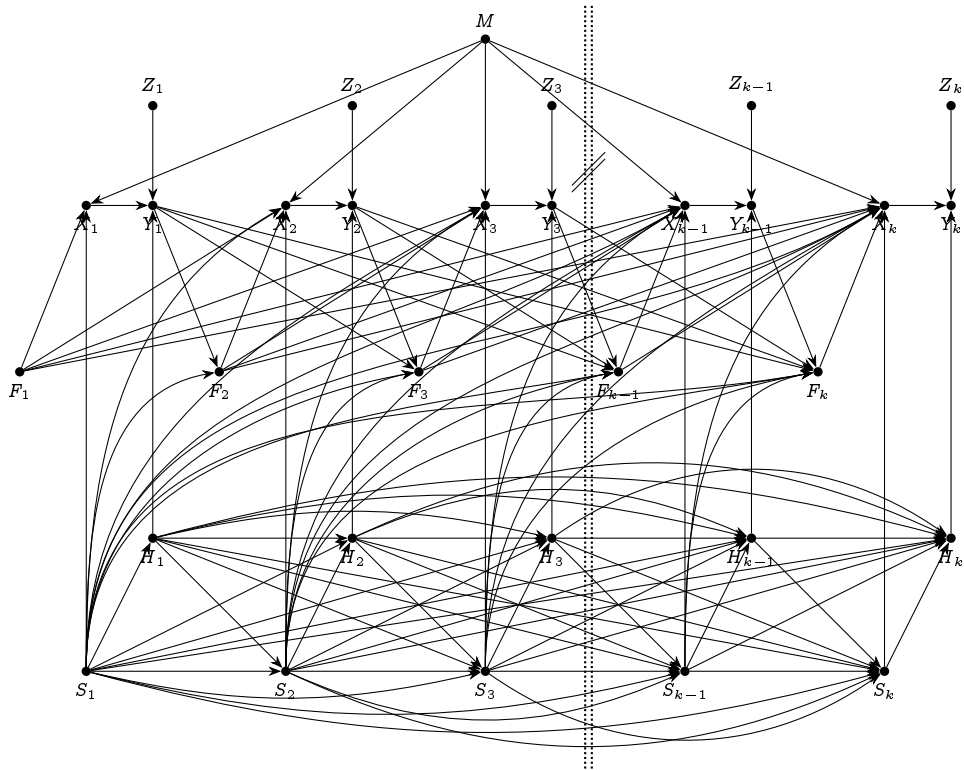

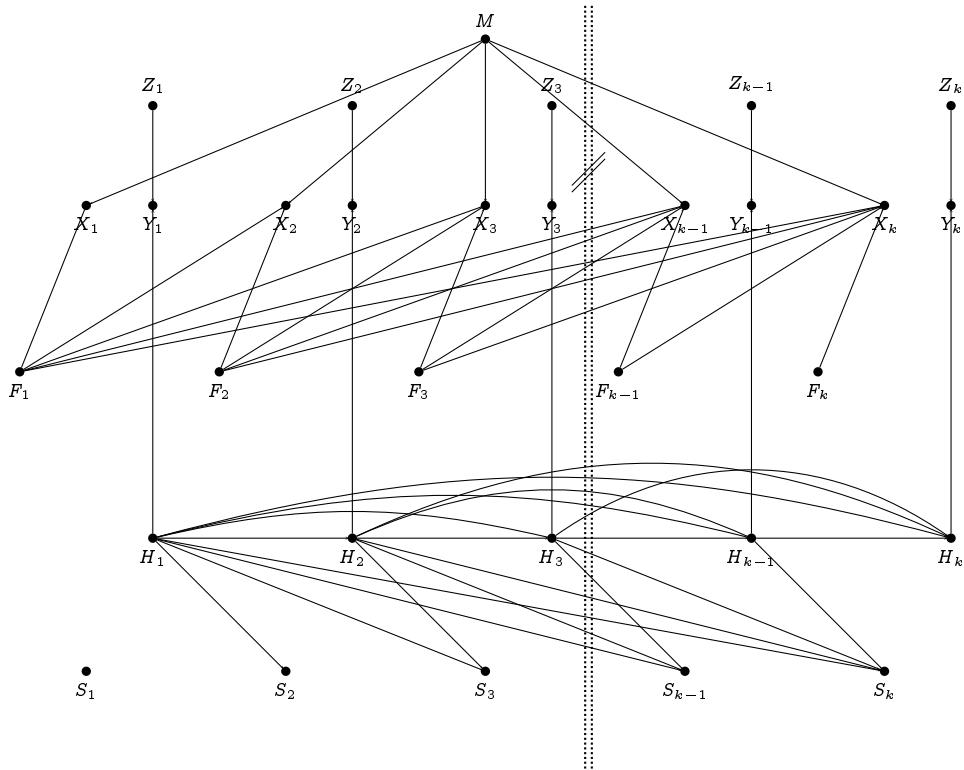

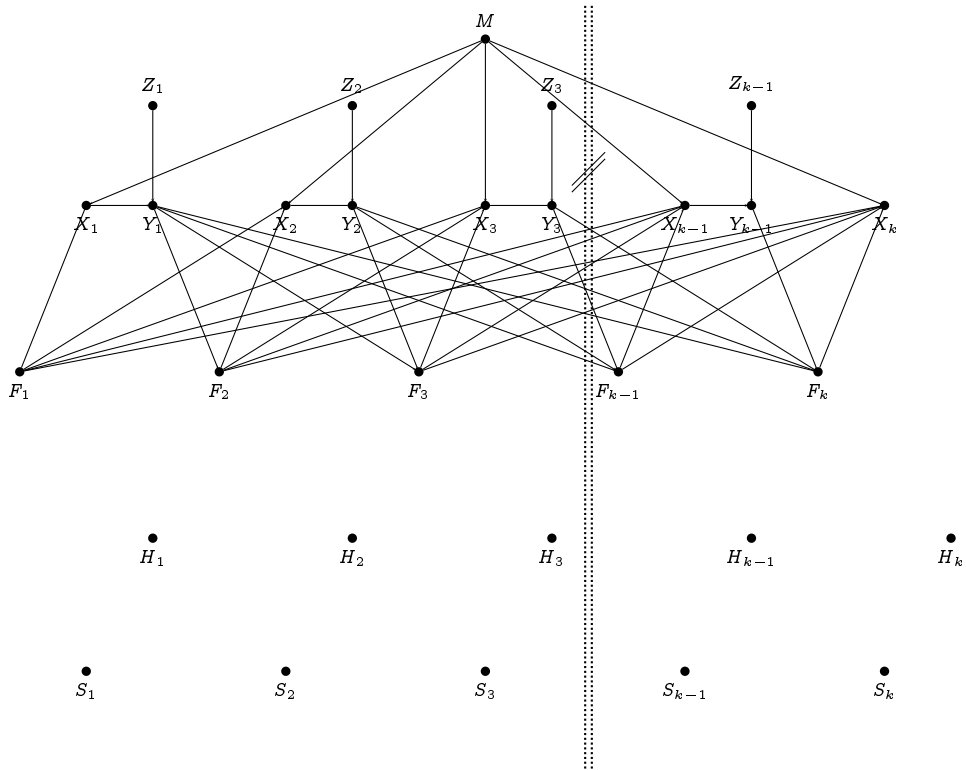

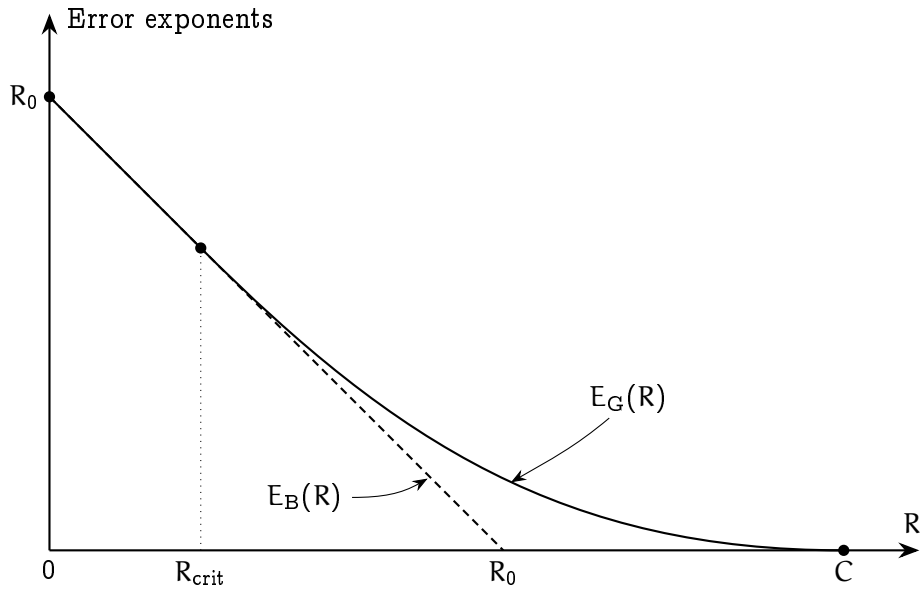

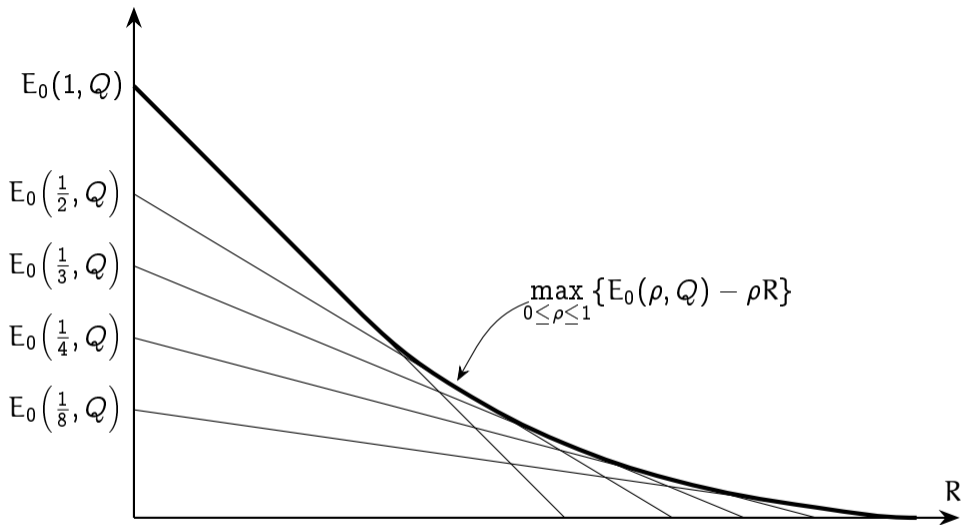

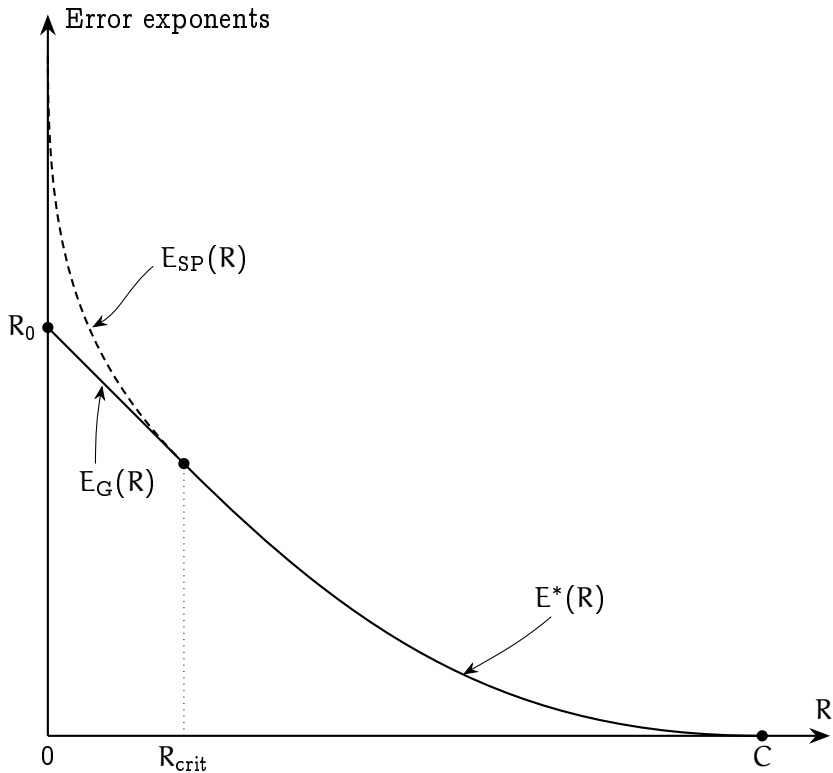

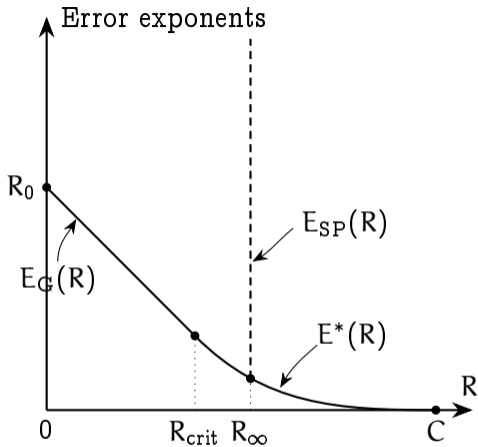
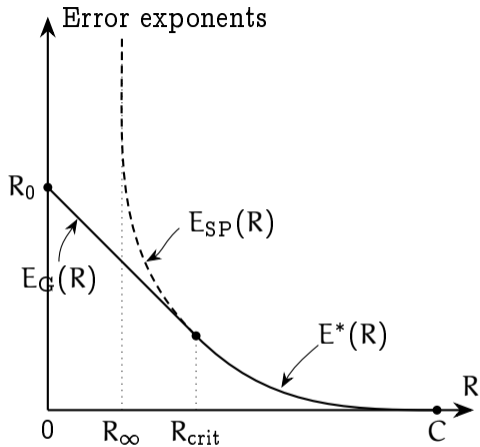



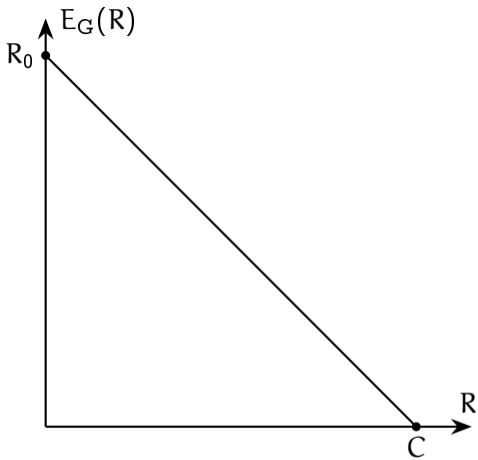
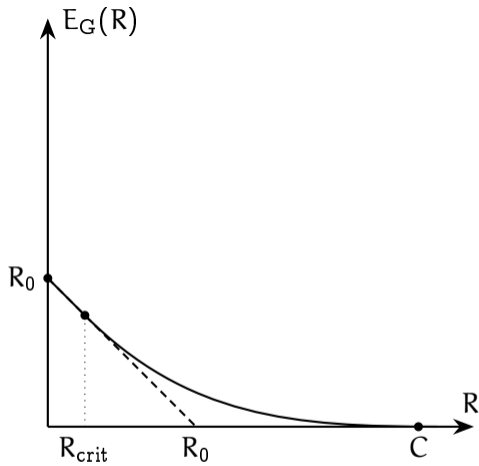

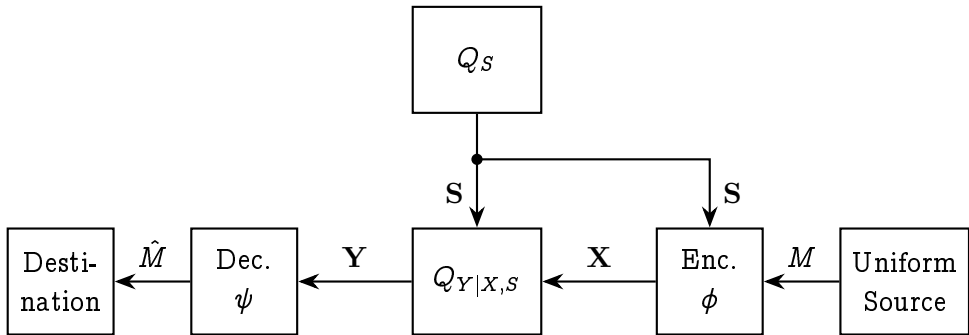

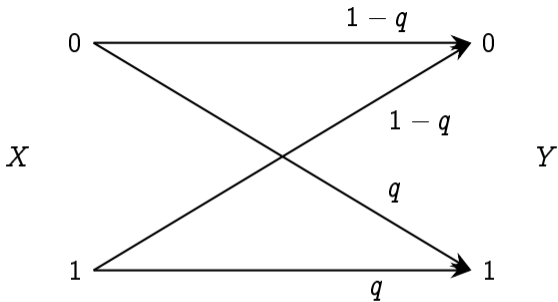

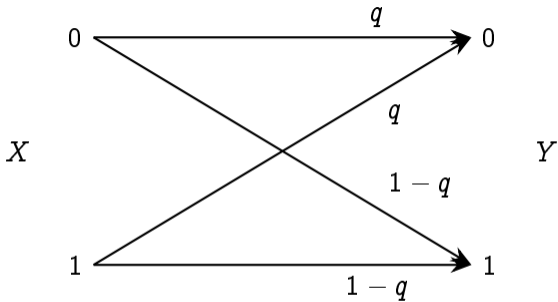

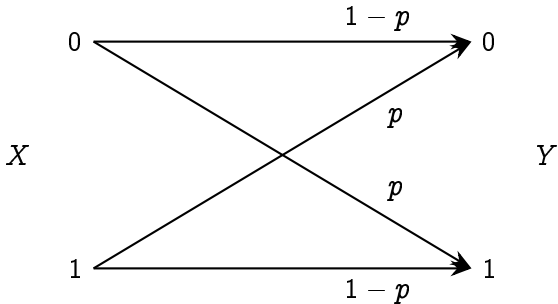

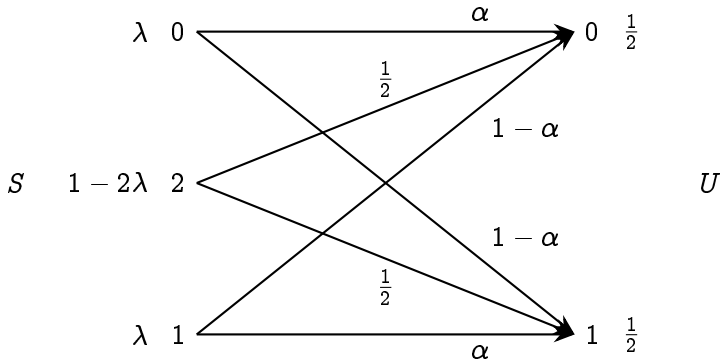

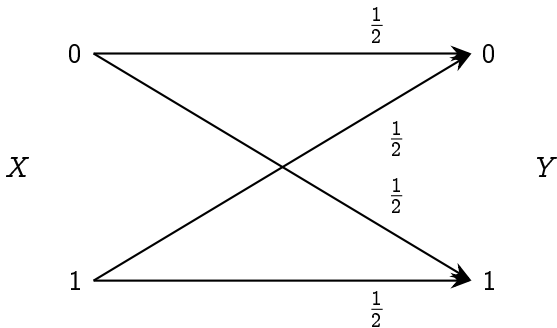

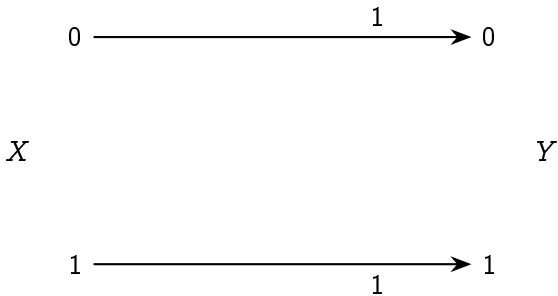



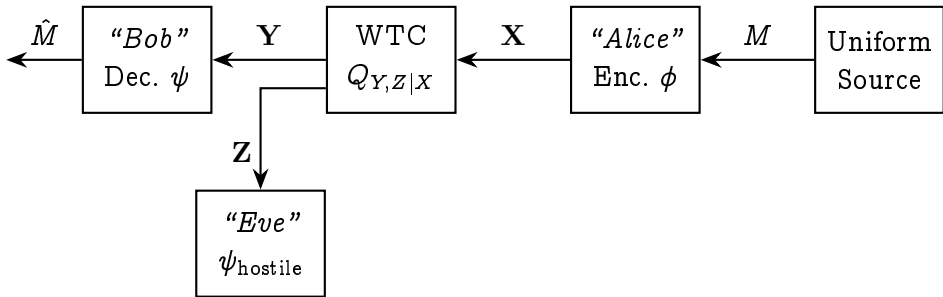

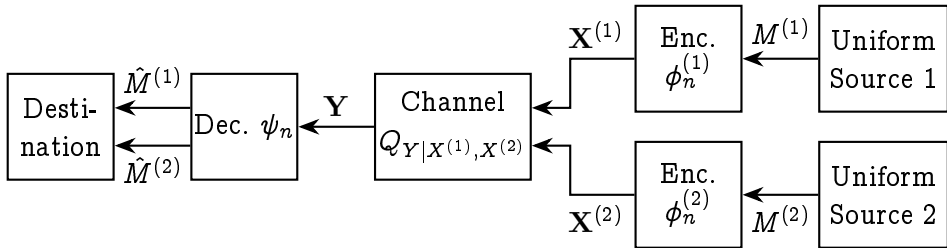

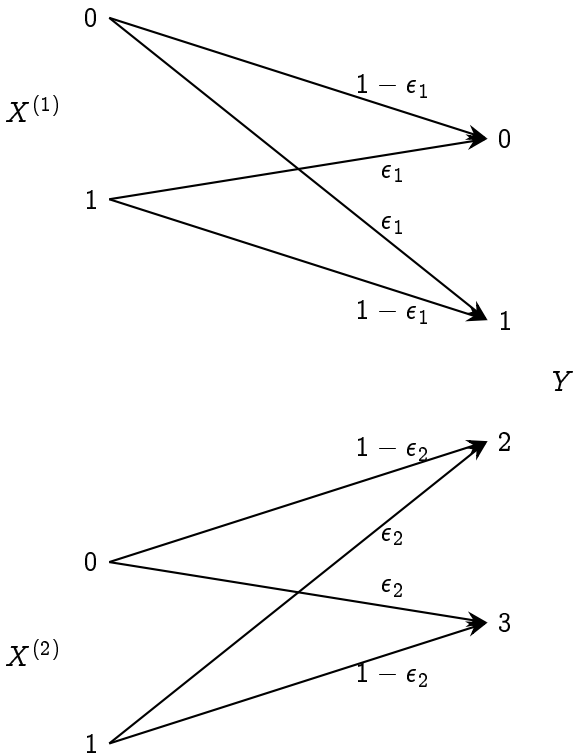

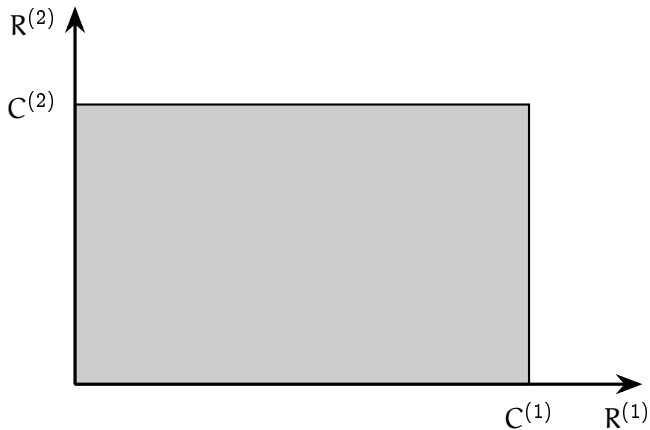

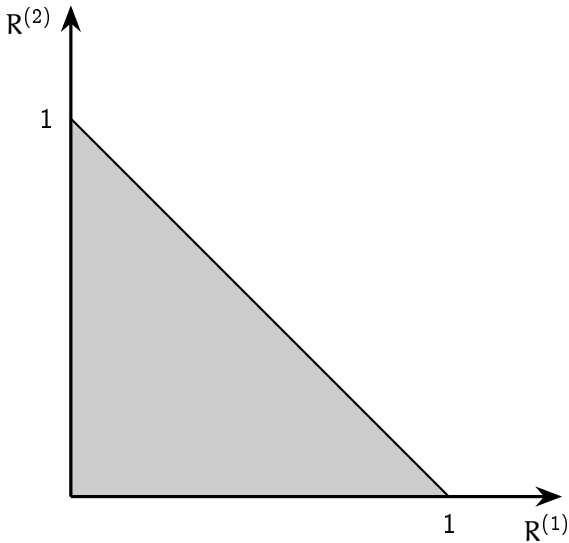

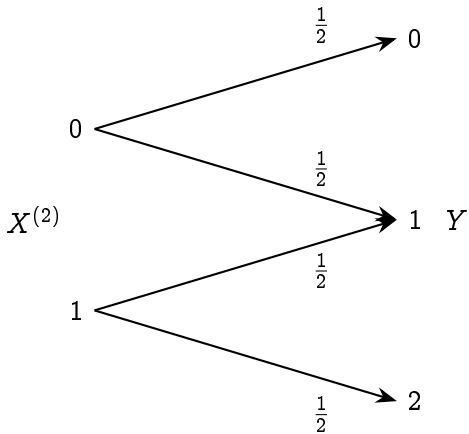

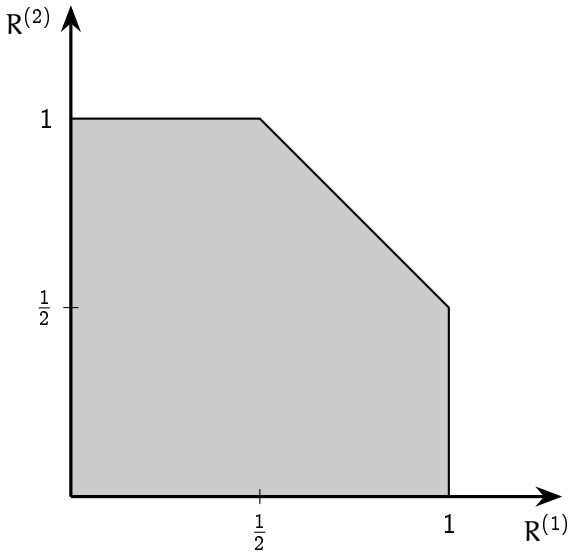

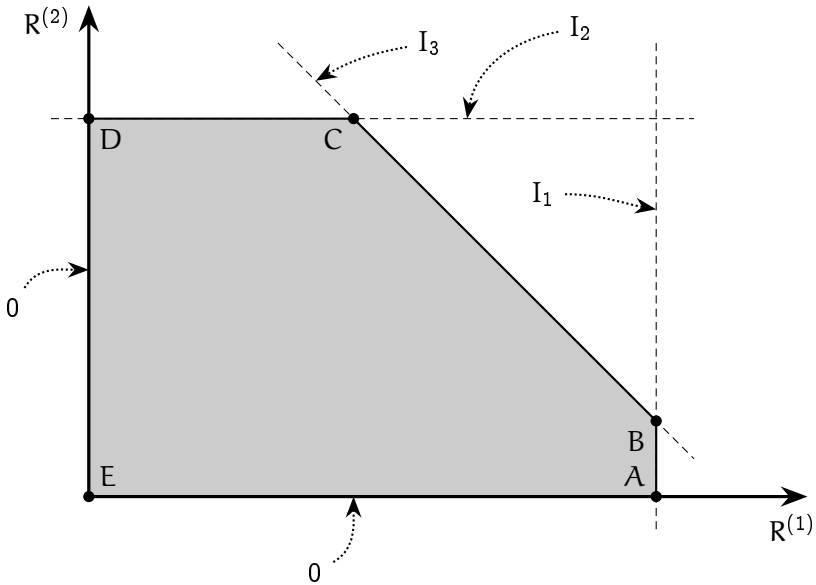



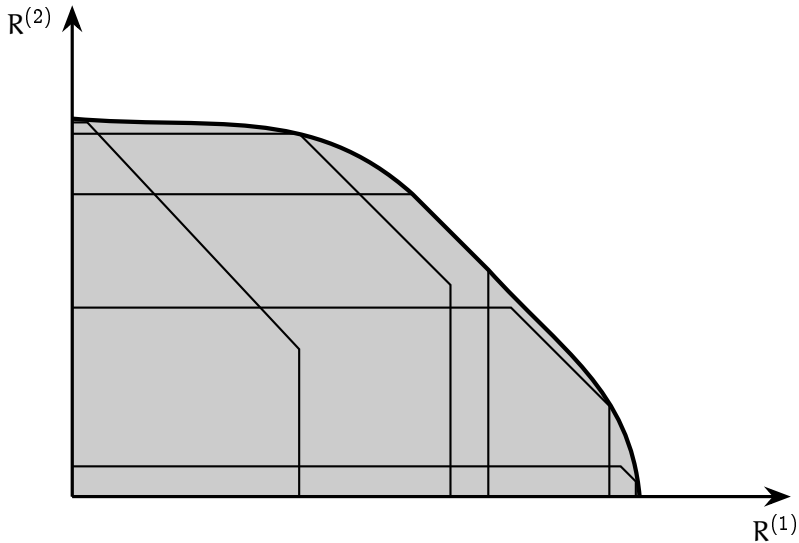

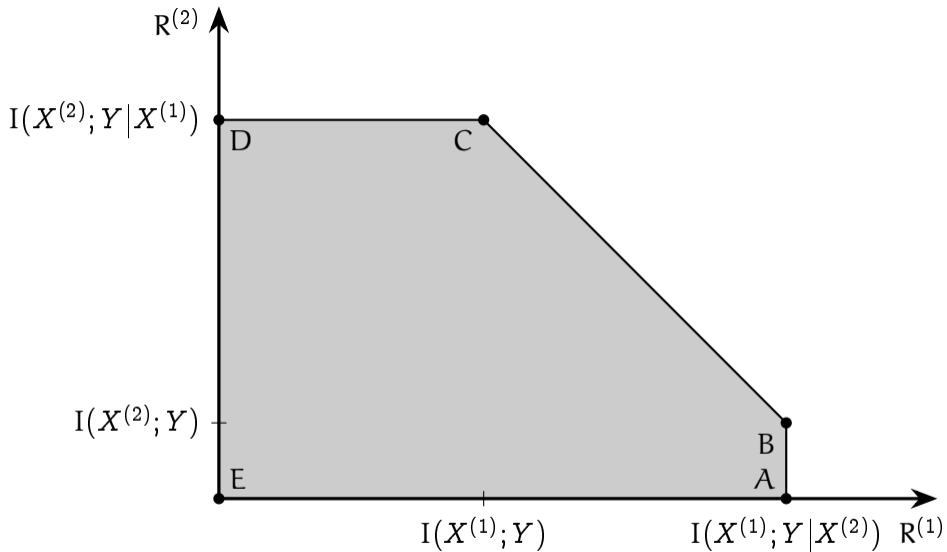

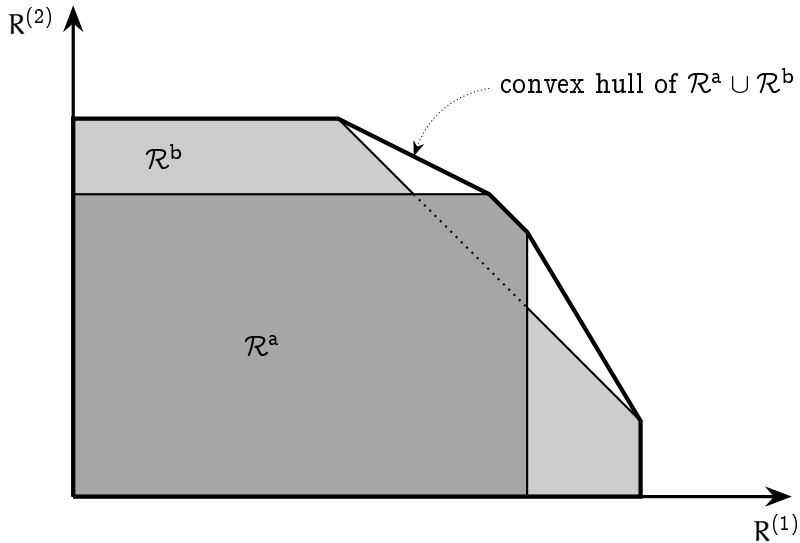

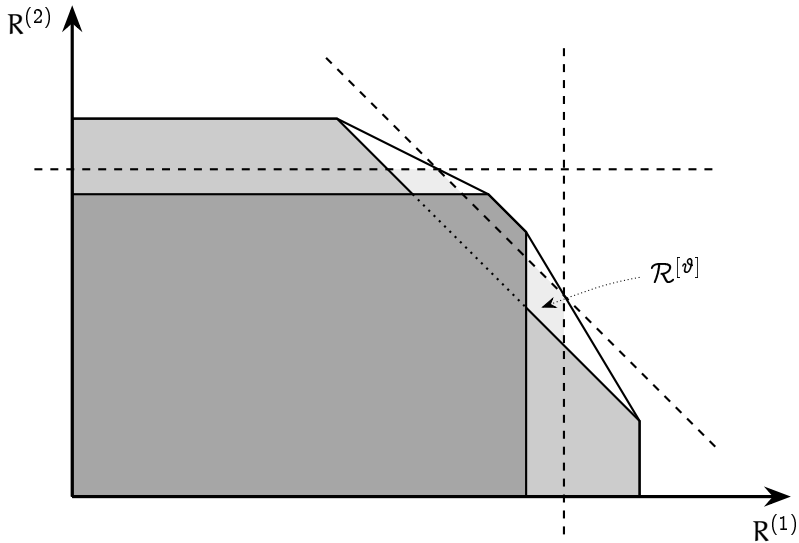

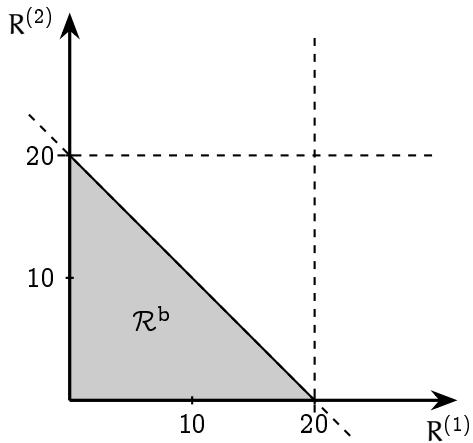
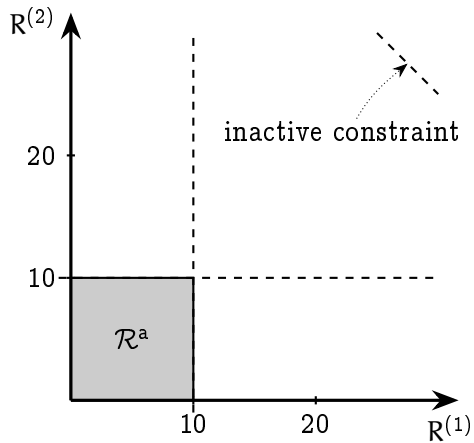

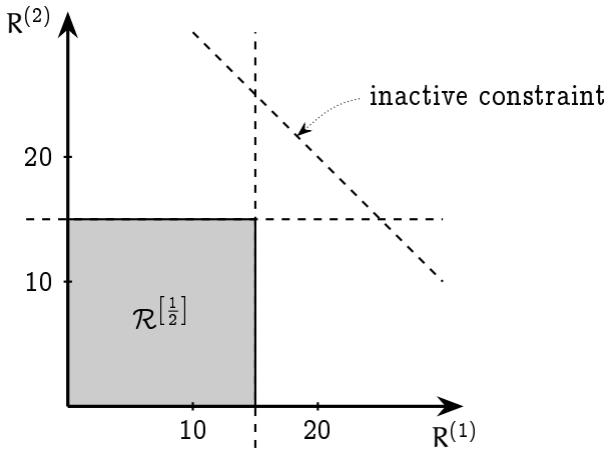

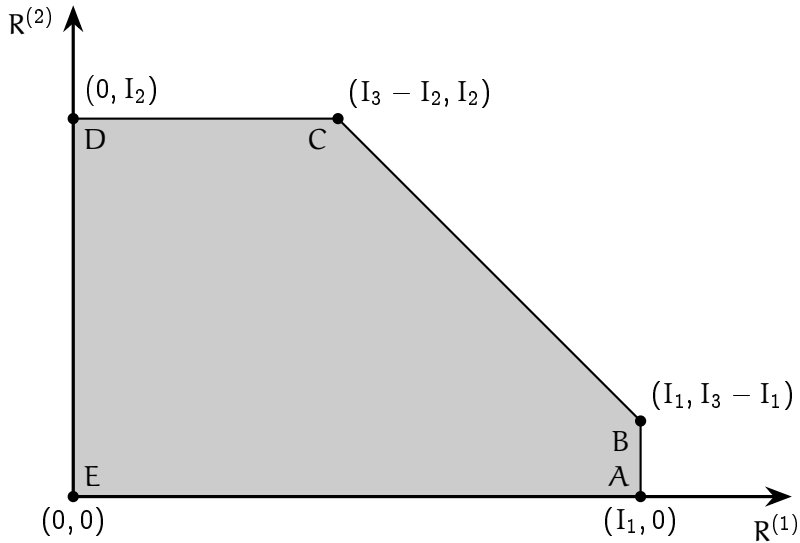

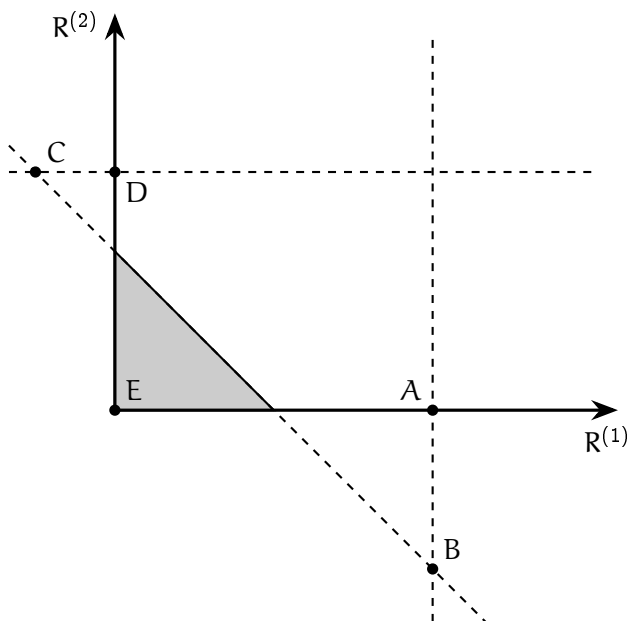
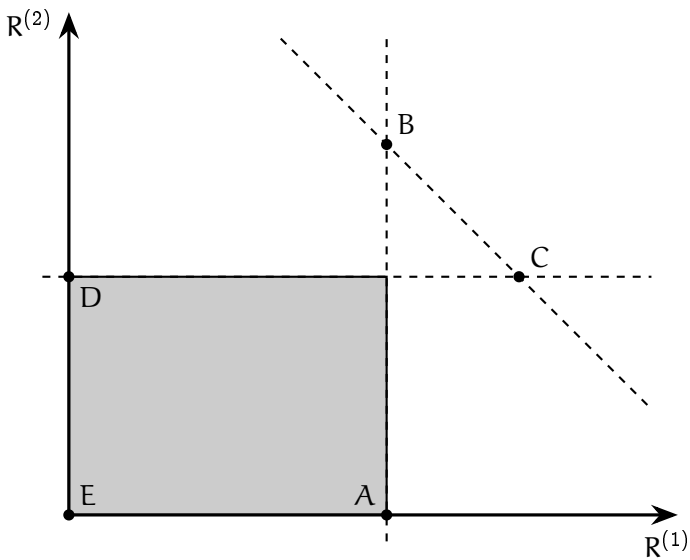



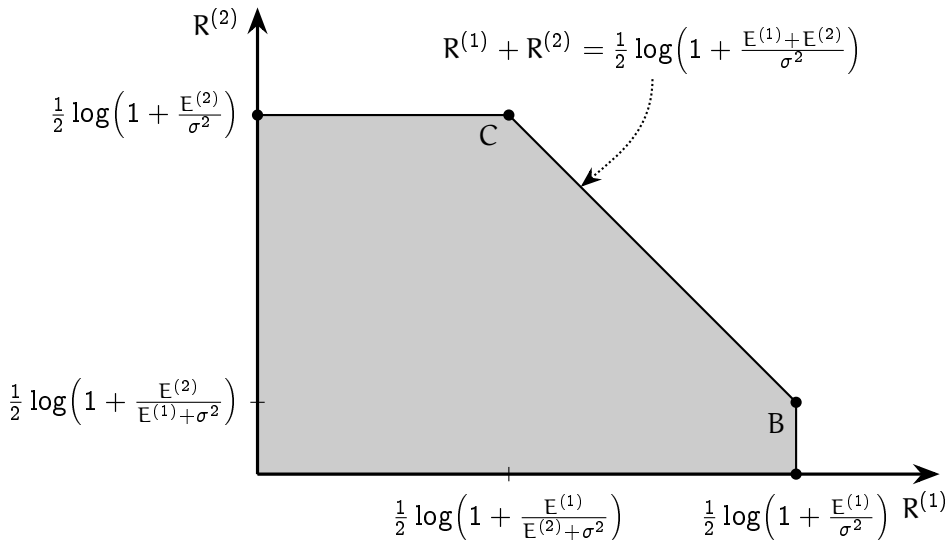

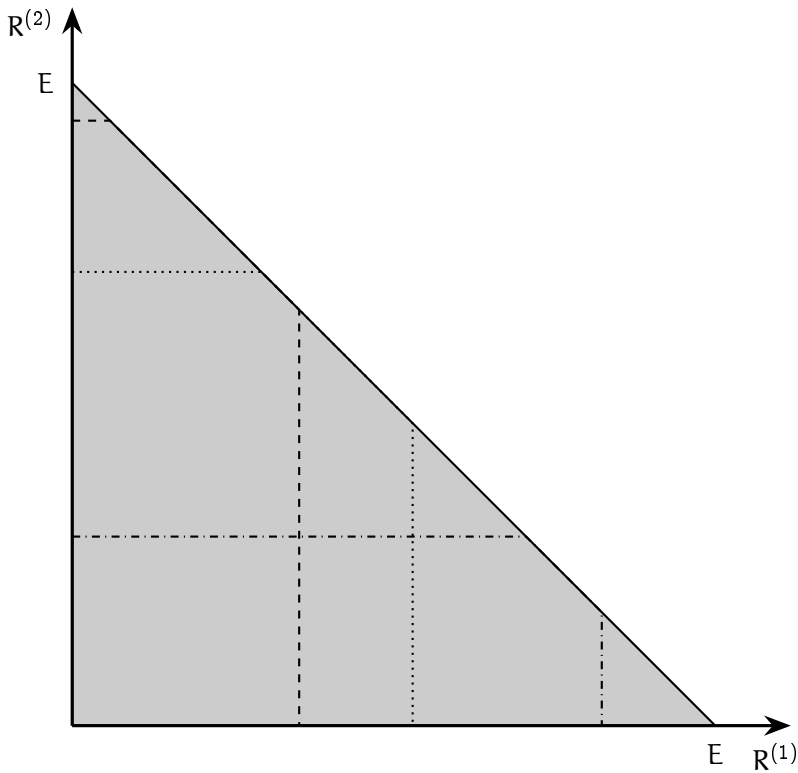

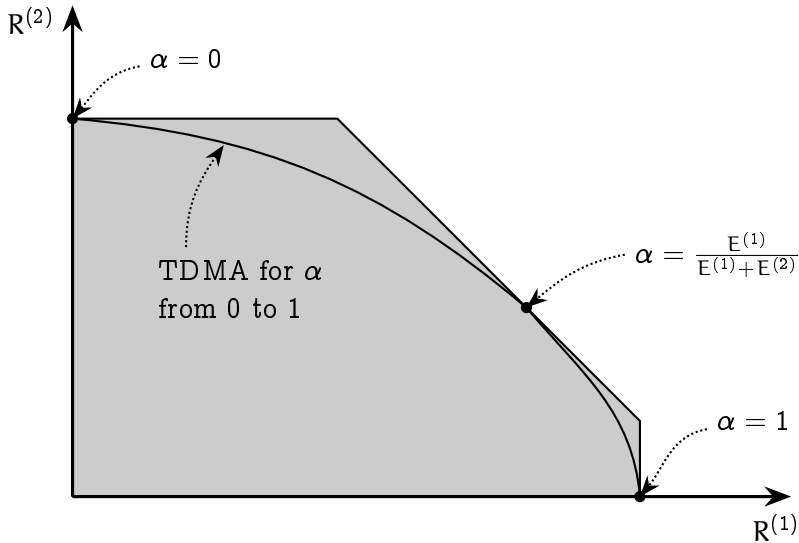

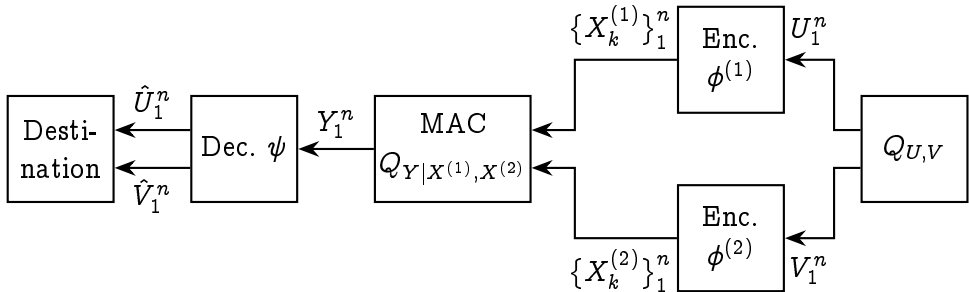

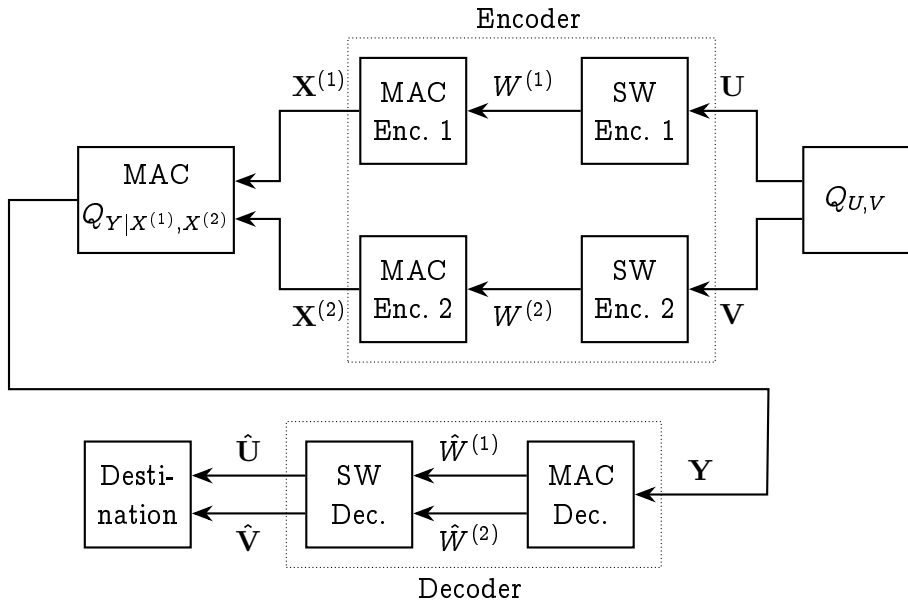

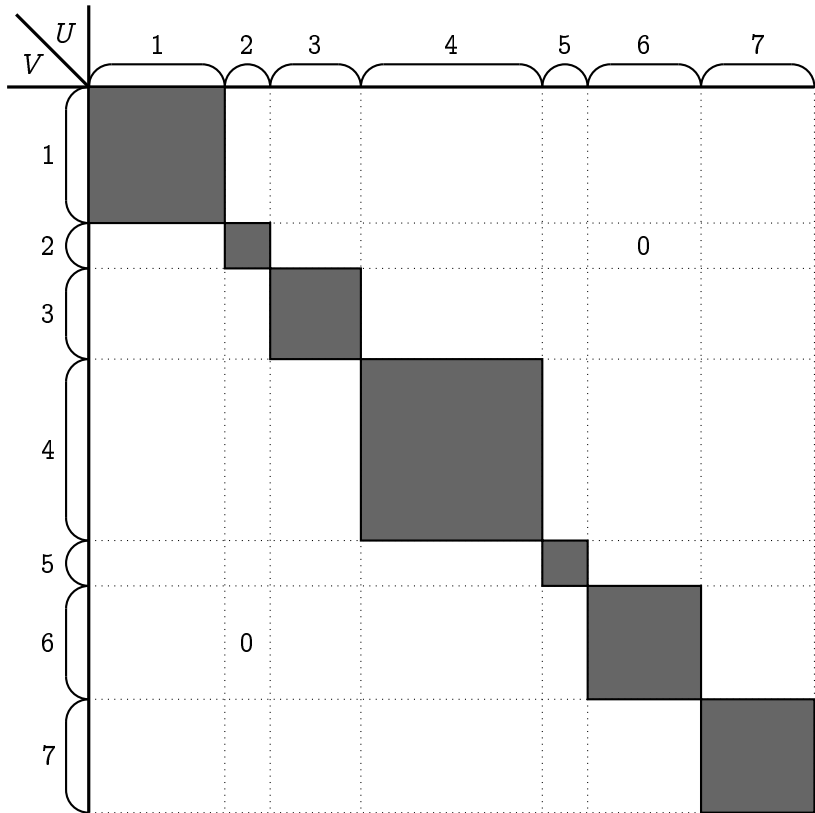

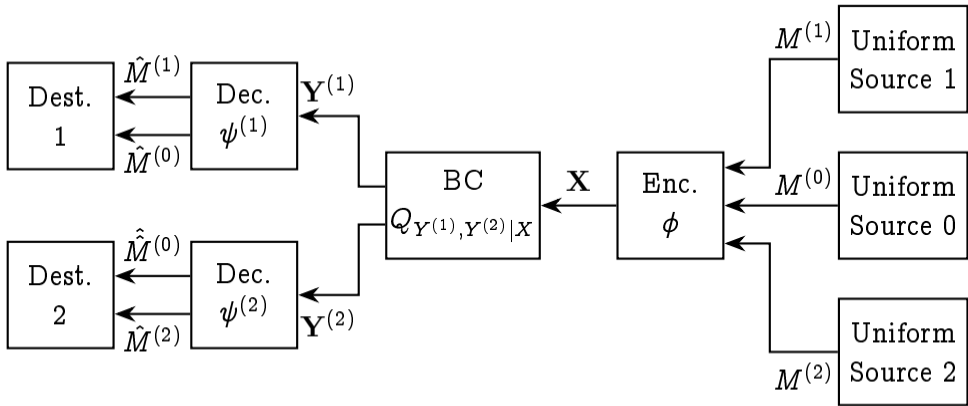

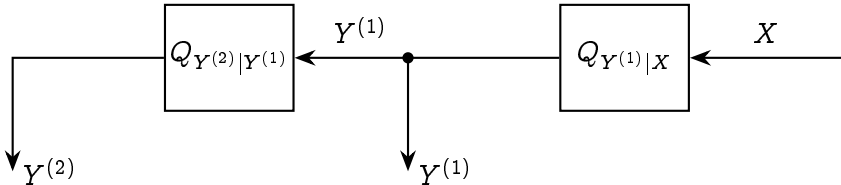



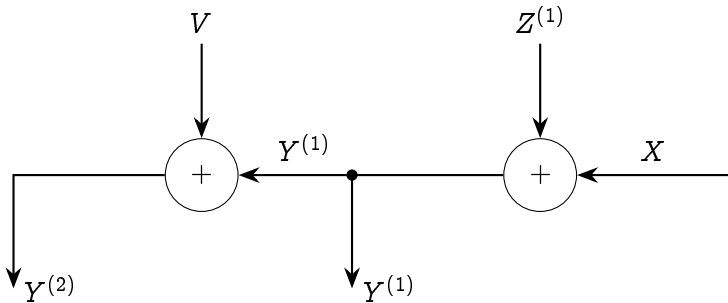

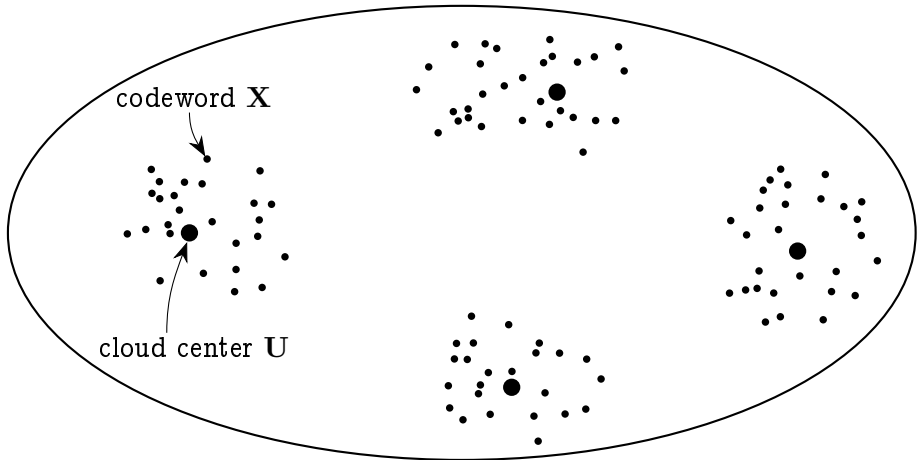

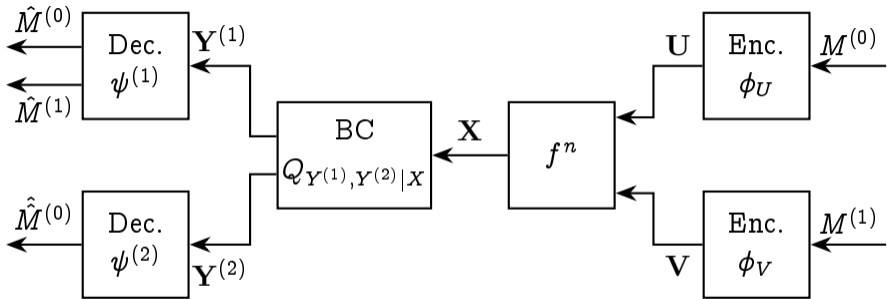

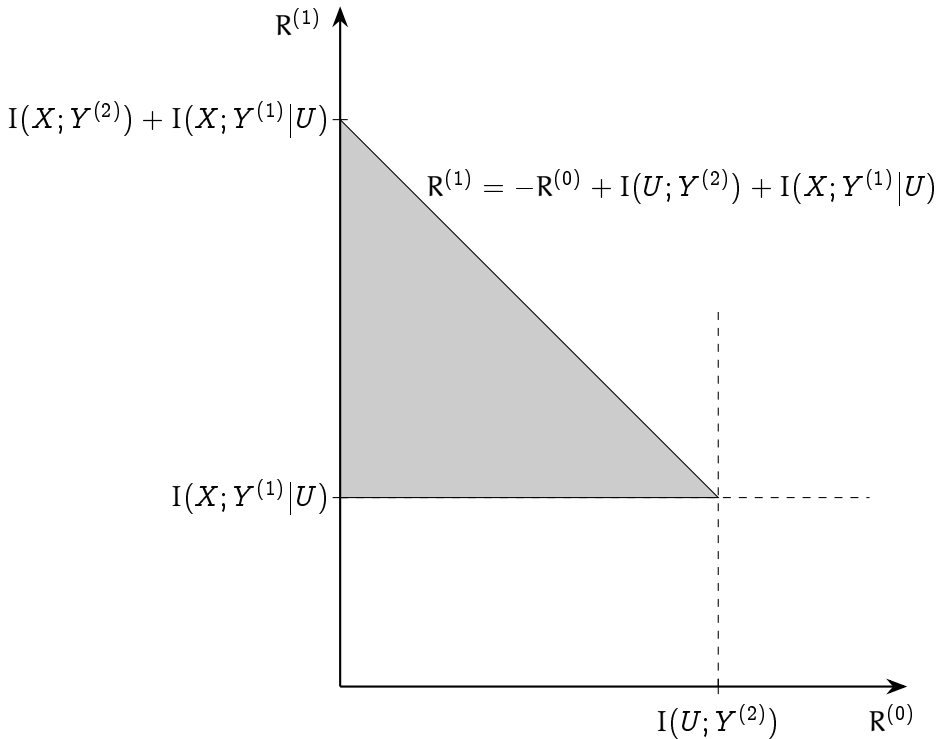

$$R^{(2)} = -R^{(1)} + I(U^{(1)}; Y^{(1)}) + I(U^{(2)}; Y^{(2)}) - I(U^{(1)}; U^{(2)})$$

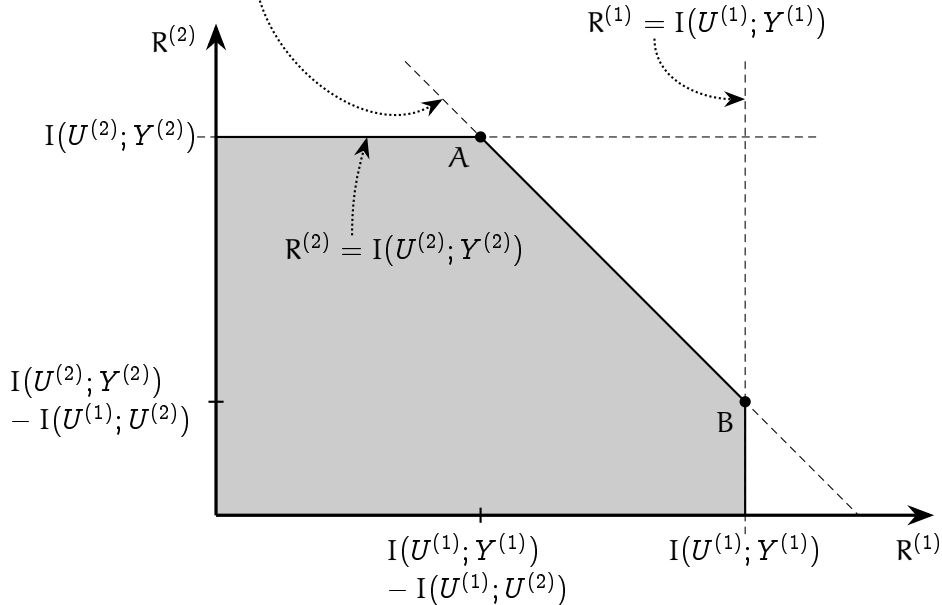

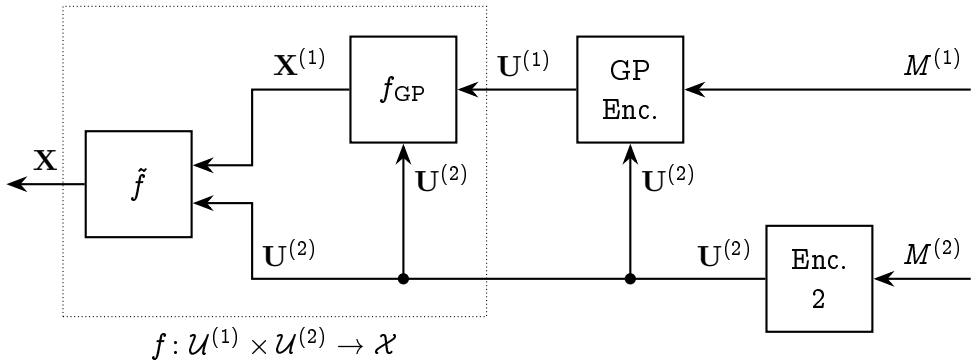

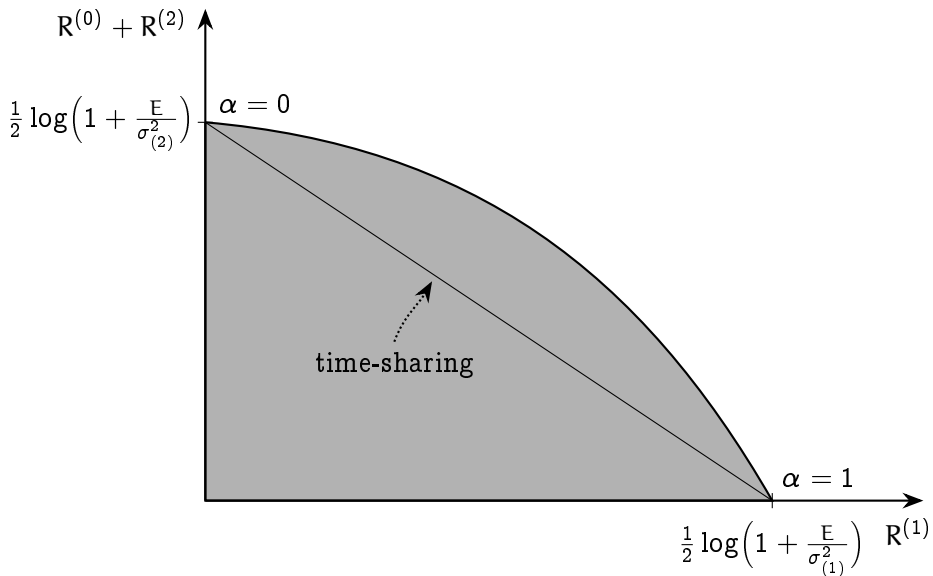

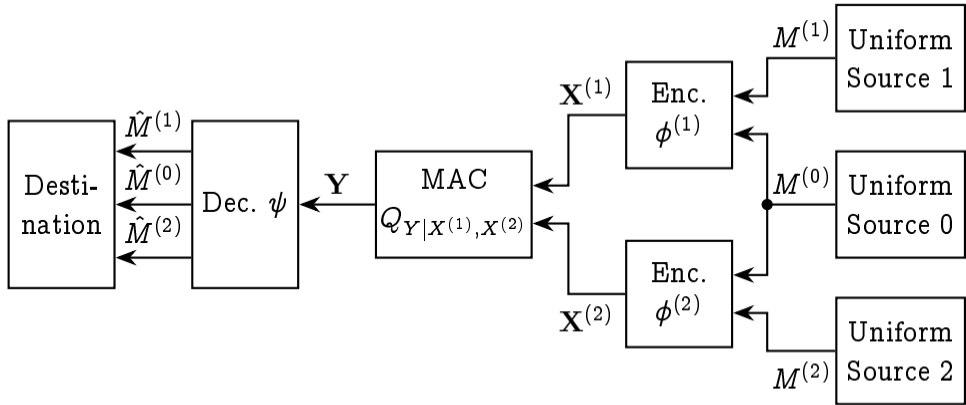



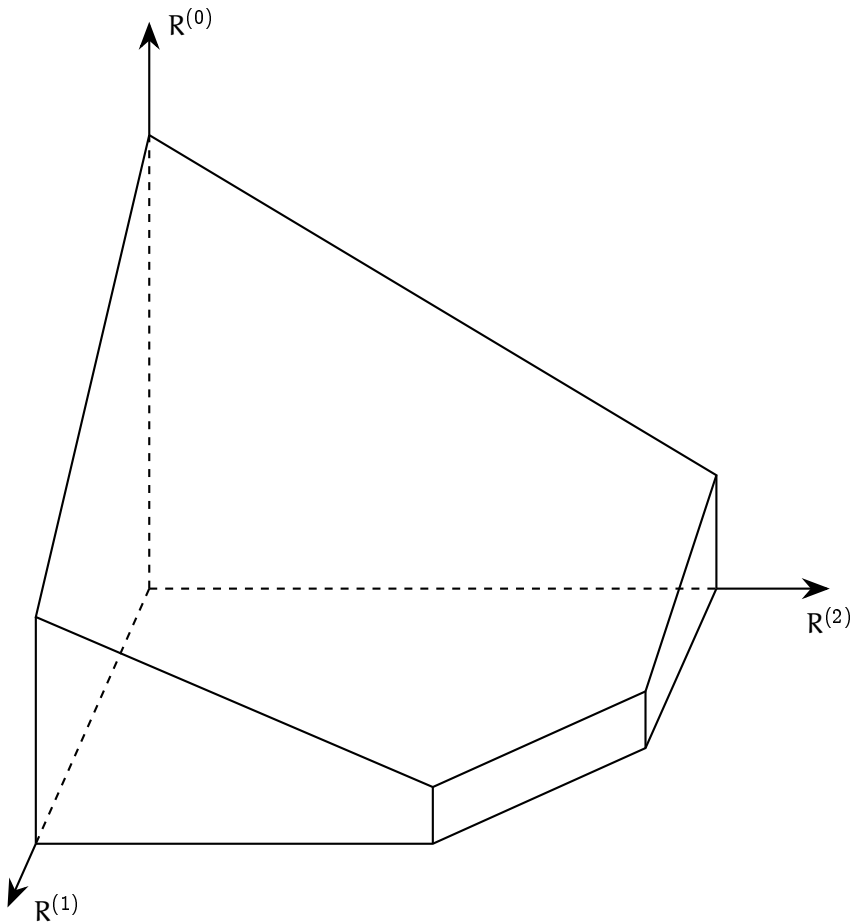

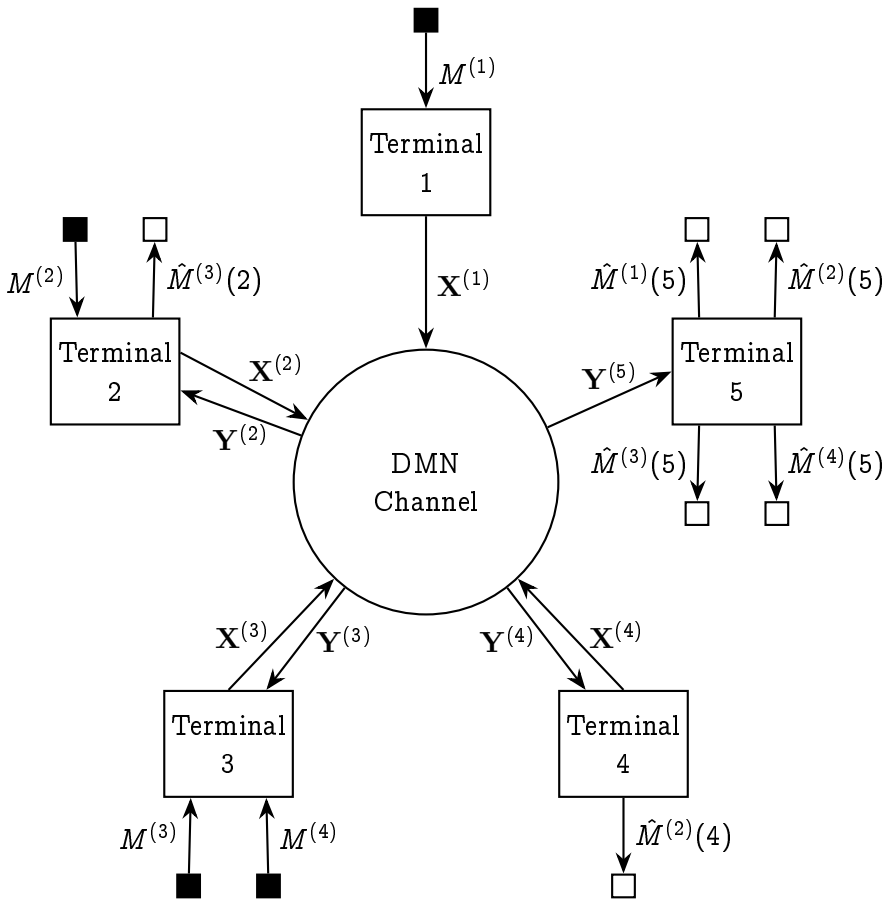

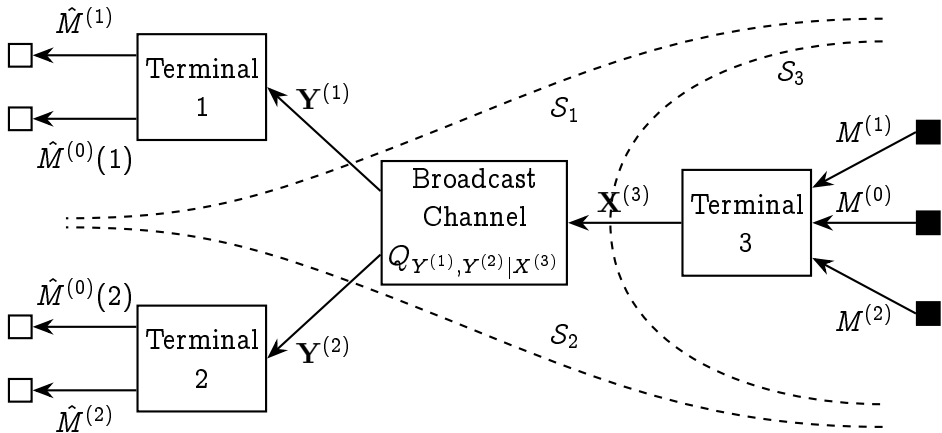

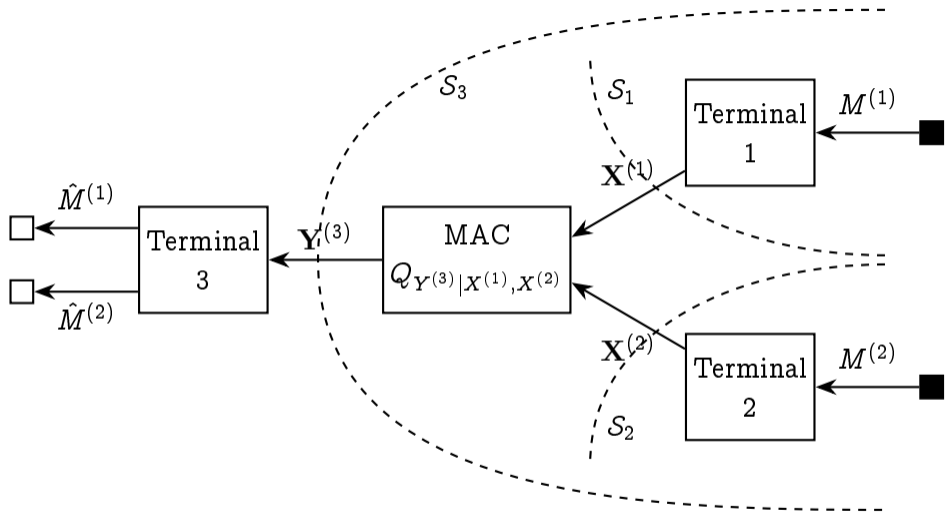

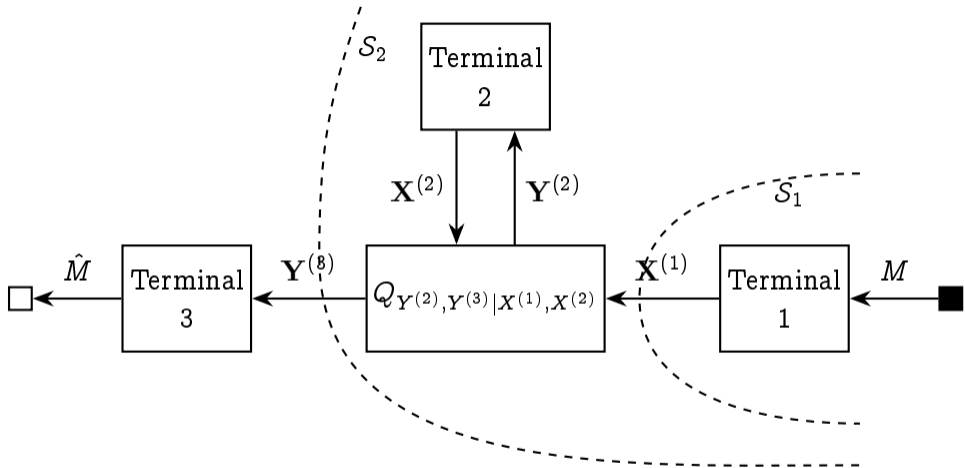

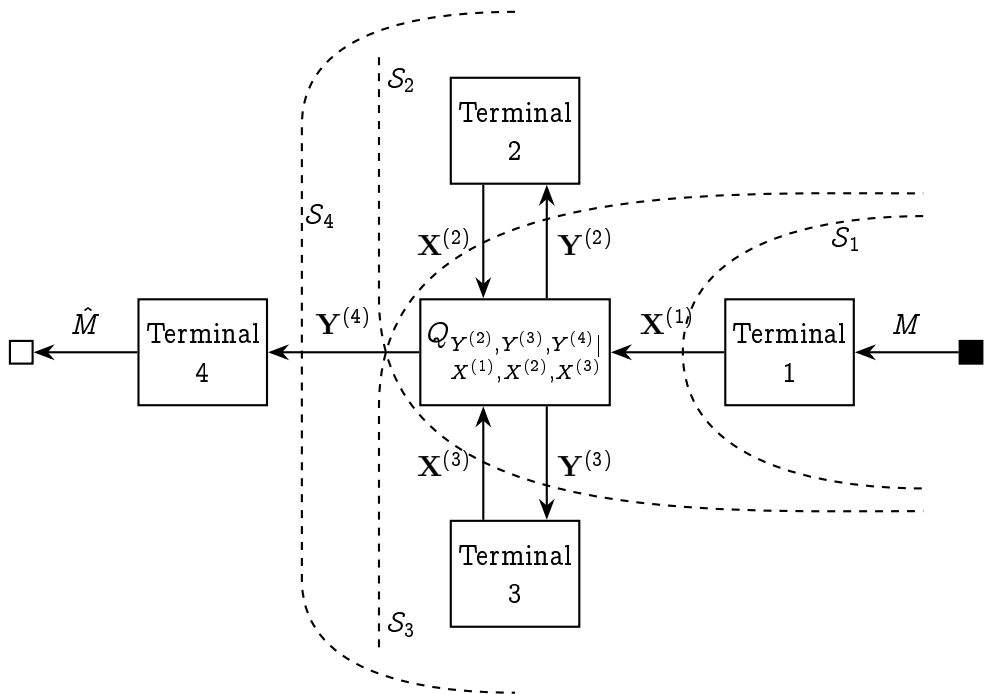

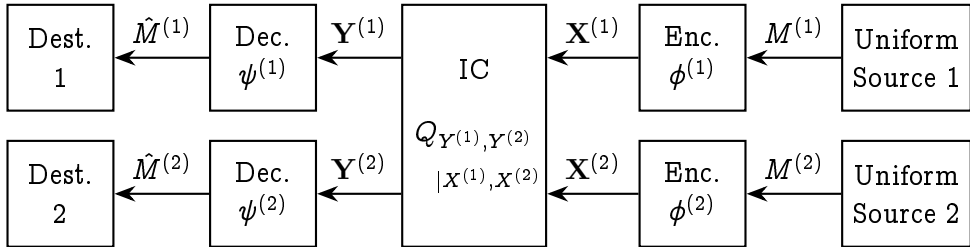

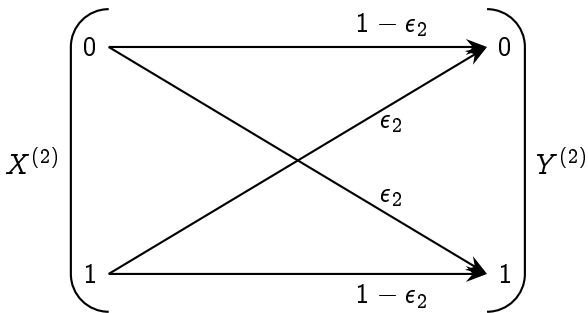
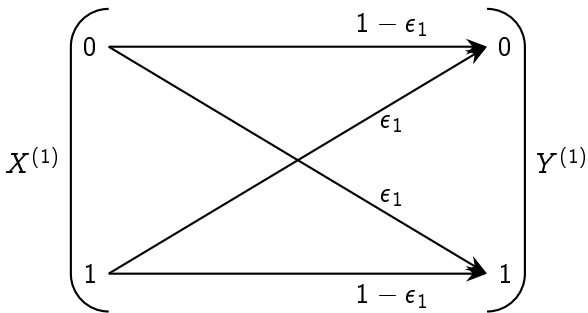



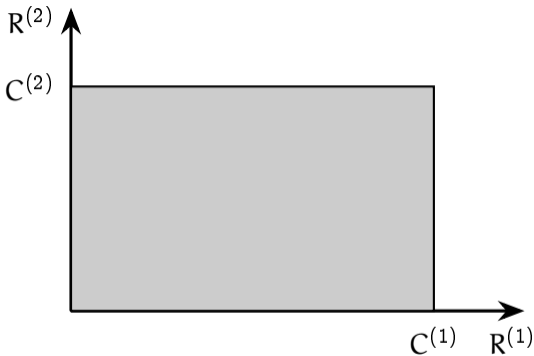

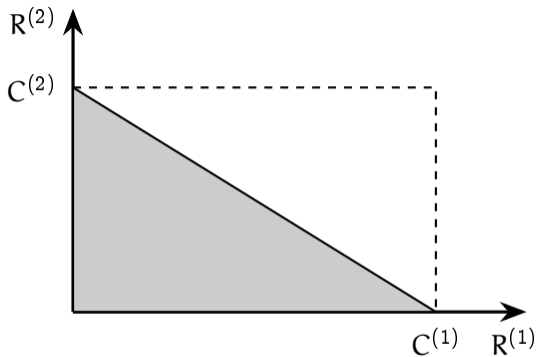

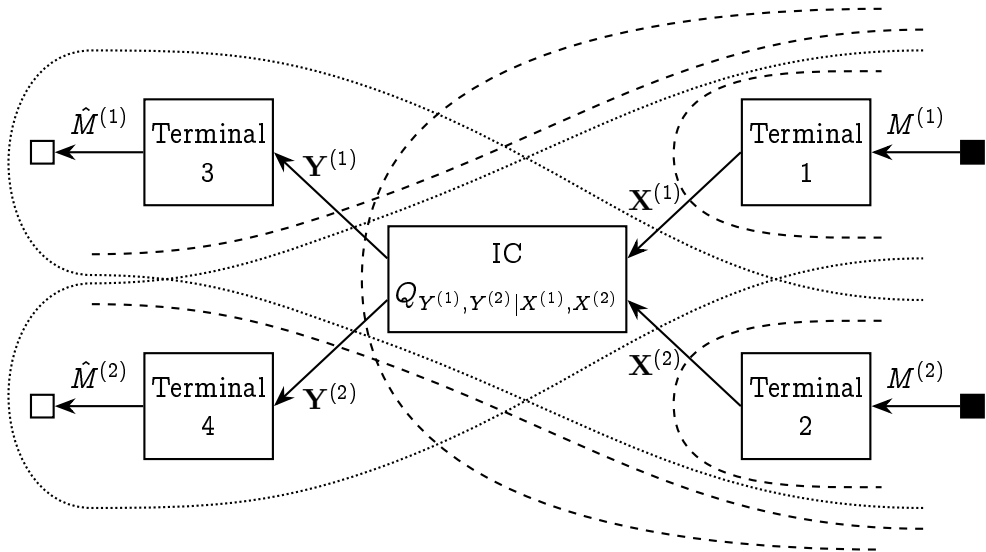

$a_{12} = 0.15, a_{21} = 0.05$

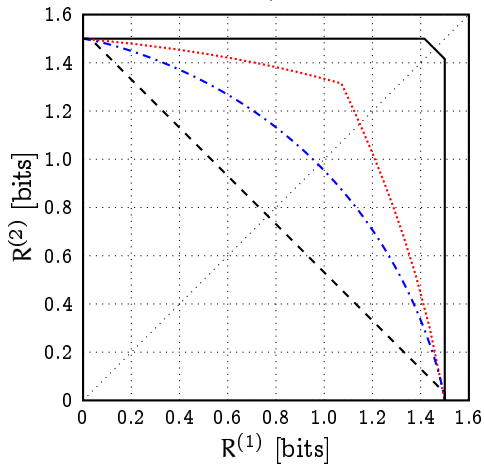

$a_{12} = 0.35, a_{21} = 0.25$

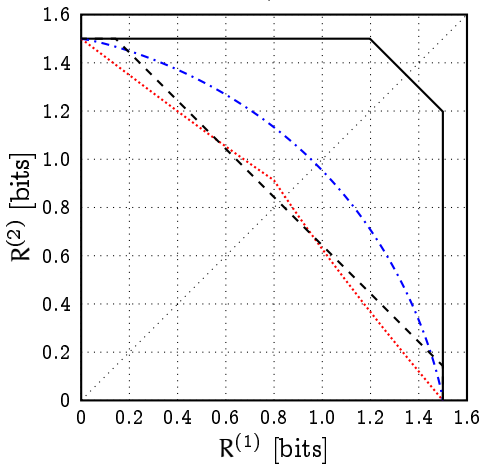

$a_{12} = 0.55, a_{21} = 0.45$

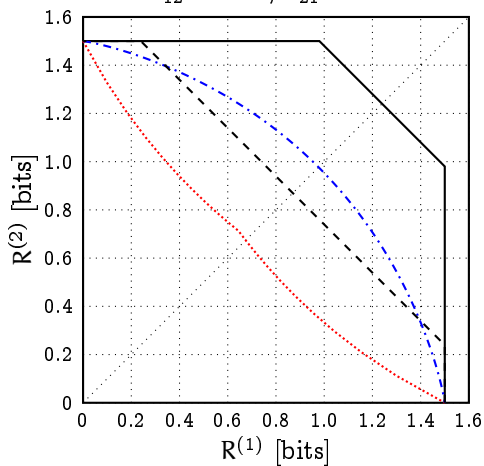

$a_{12} = 0.85, a_{21} = 0.75$

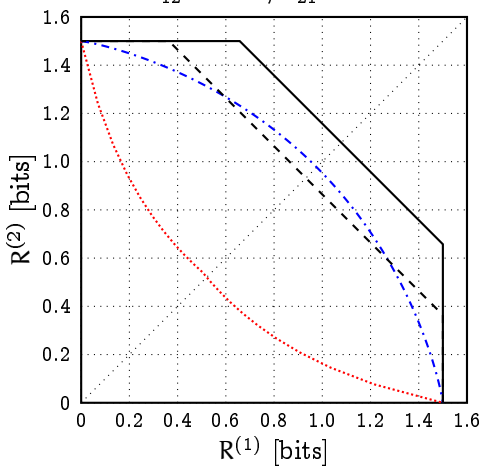

$a_{12} = 1.15, a_{21} = 1.05$

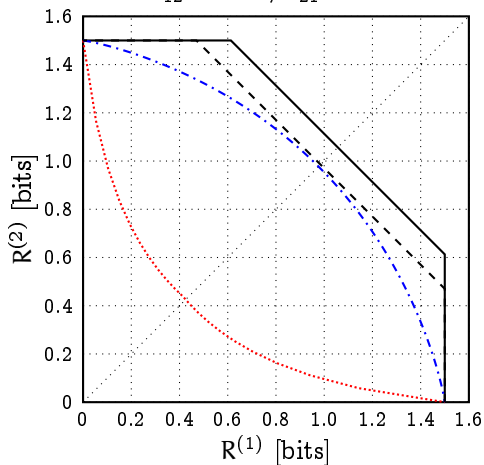

$a_{12} = 2.15, a_{21} = 2.05$

