



# Information Theory

Lecture Notes

Stefan M. Moser

© Copyright Stefan M. Moser

Signal and Information Processing Lab  
ETH Zurich  
Zurich, Switzerland

Institute of Communications Engineering  
National Yang Ming Chiao Tung University (NYCU)  
Hsinchu, Taiwan

You are welcome to use these lecture notes for yourself, for teaching, or for any other noncommercial purpose. If you use extracts from these lecture notes, please make sure to show their origin. The author assumes no liability or responsibility for any errors or omissions.

6<sup>th</sup> Edition — 2018.

Version 6.15.

Compiled on 11 March 2024.

For the latest version see <https://moser-isi.ethz.ch/scripts.html>

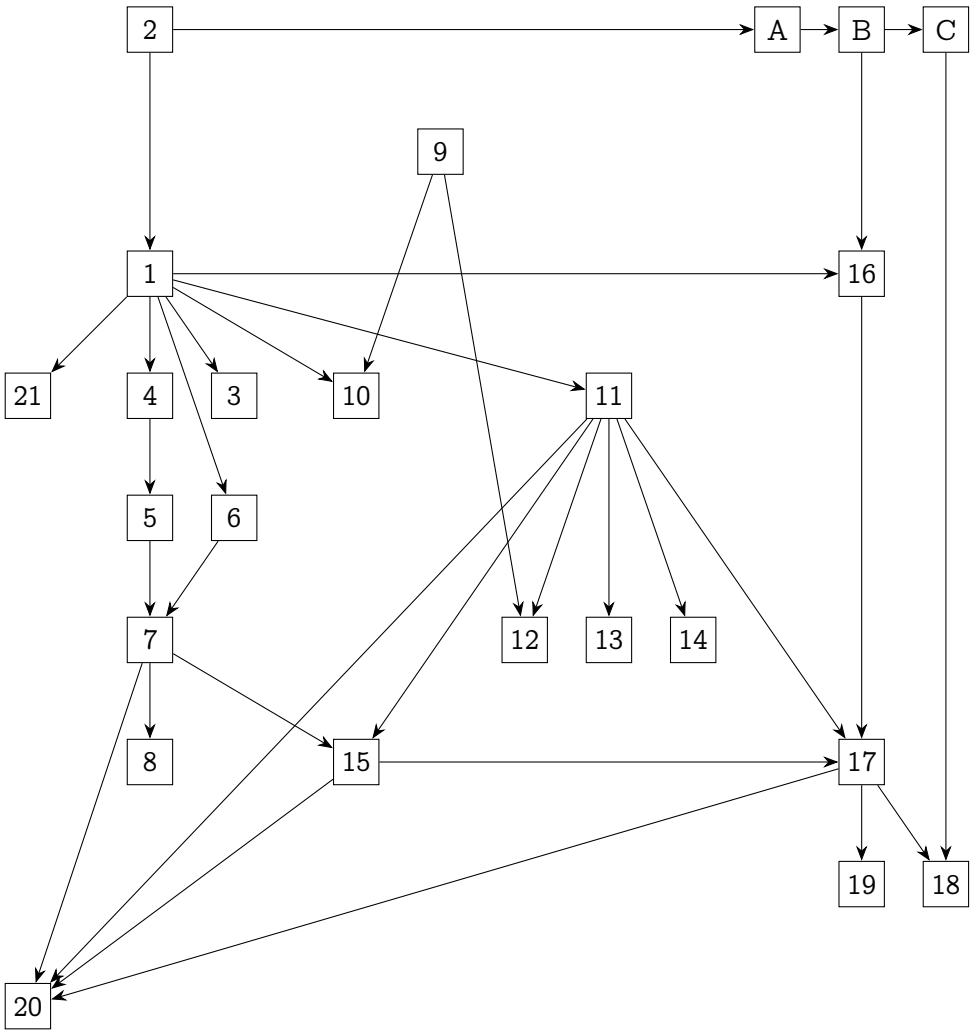

Chapter dependency chart. An arrow has the meaning of “is required for”.

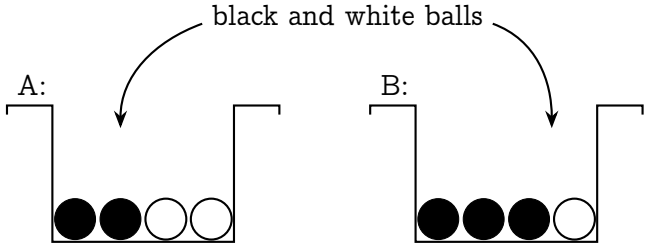

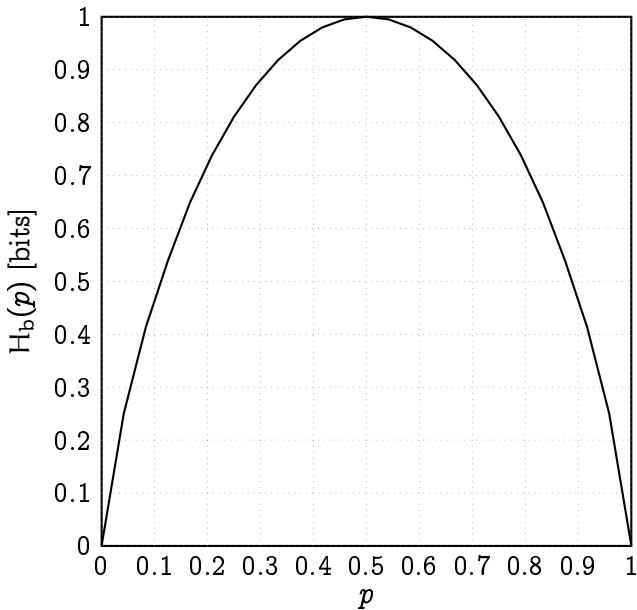

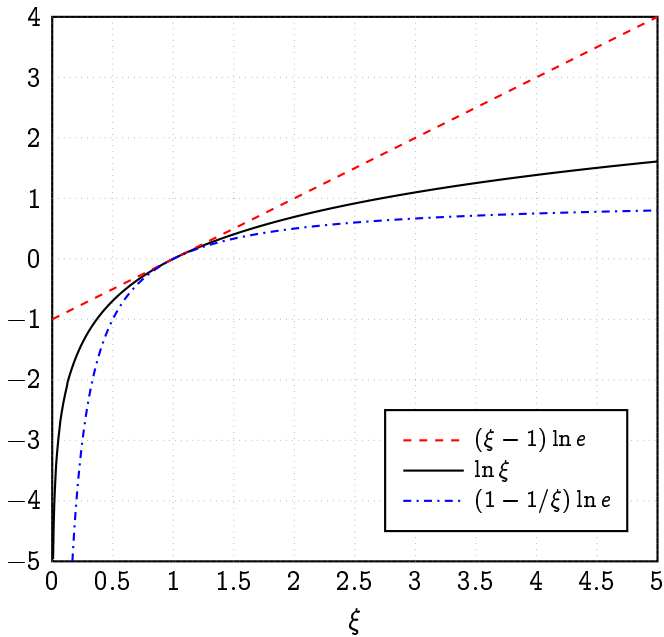

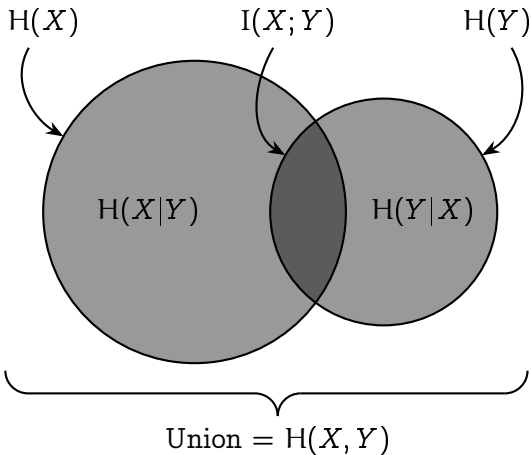

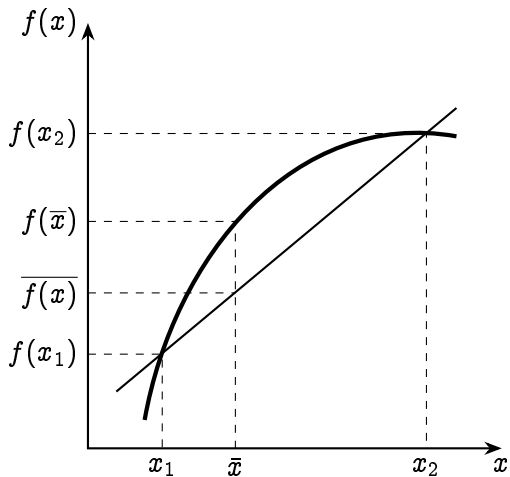
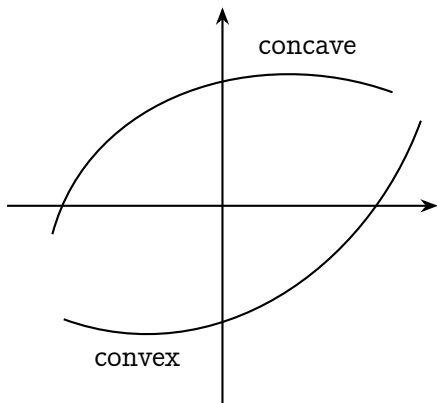

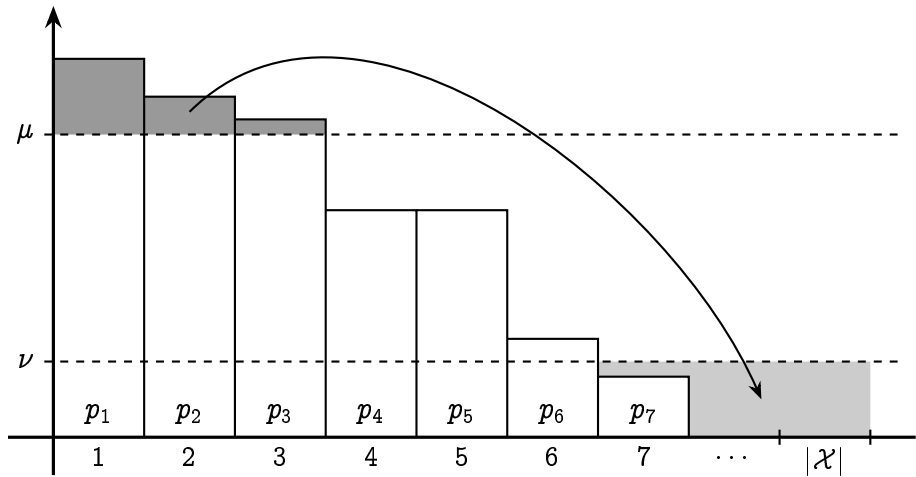



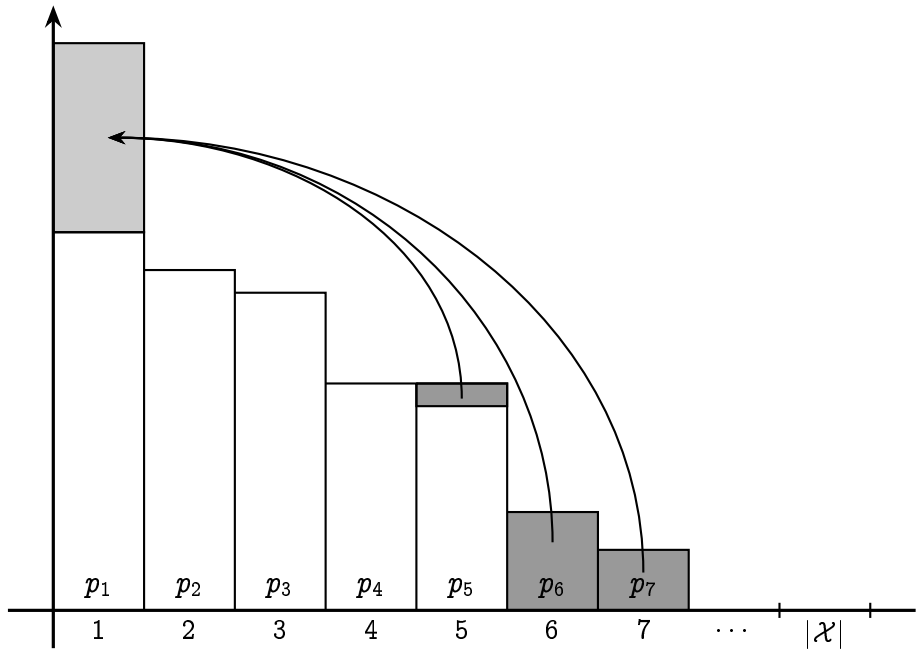

---

Friend		Alice	Bob	Carol
Probability		$\frac{1}{4}$	$\frac{1}{2}$	$\frac{1}{4}$

---

Phone numbers	(i)	0011	0011	1100
	(ii)	001101	001110	110000
	(iii)	0	1	10
	(iv)	00	11	10
	(v)	0	11	10
	(vi)	10	0	11

---

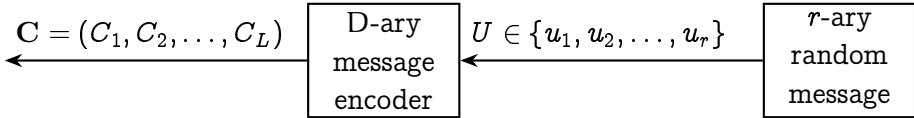

parent node with two children

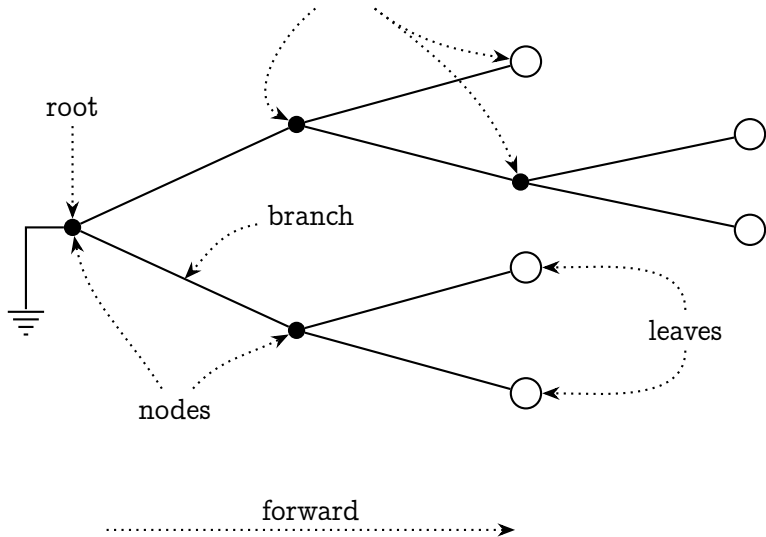

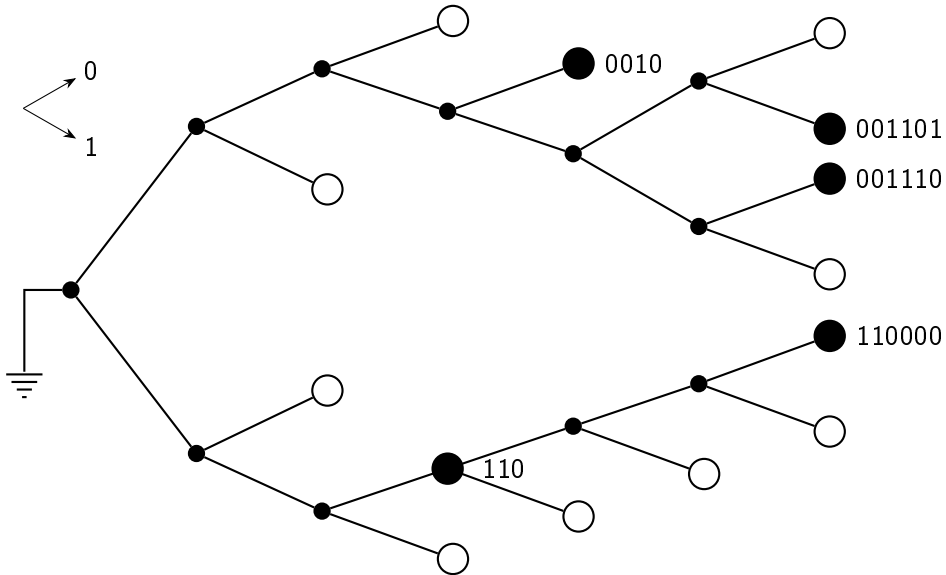

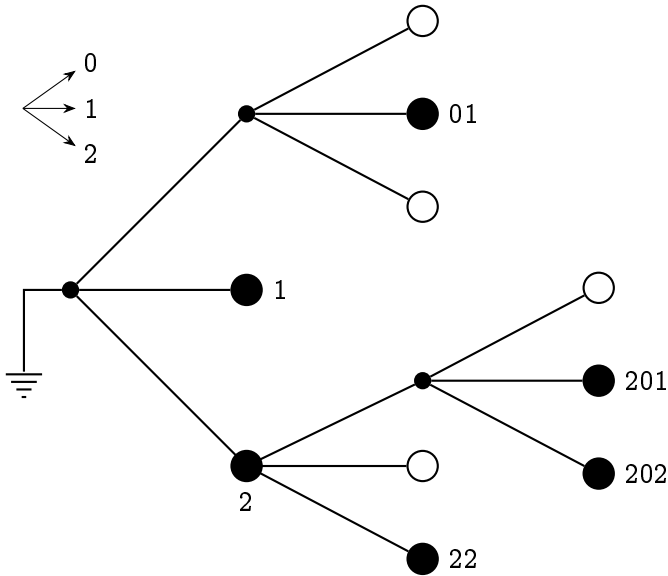

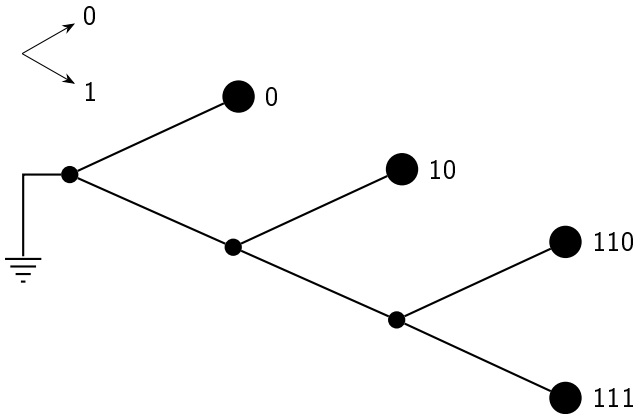

(iii)

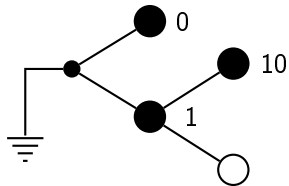

not prefix-free

(iv)

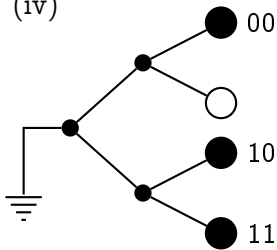

prefix-free

(v)-(vi)

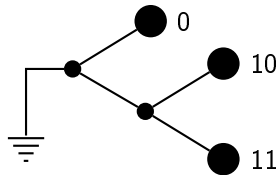

prefix-free



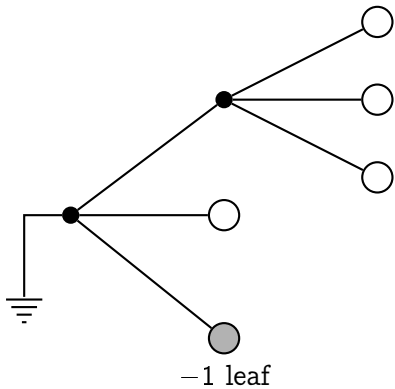

$\Rightarrow$

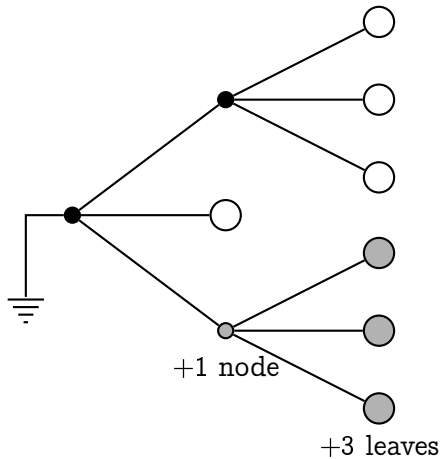

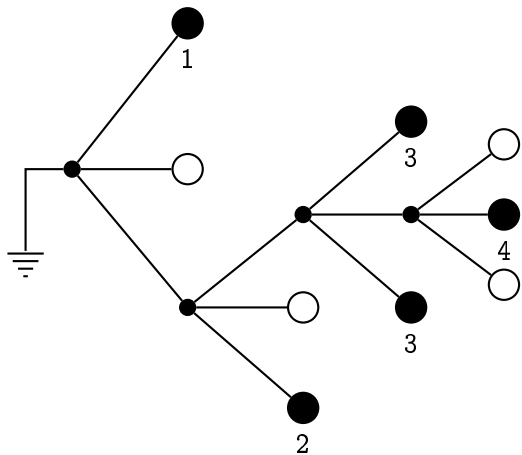
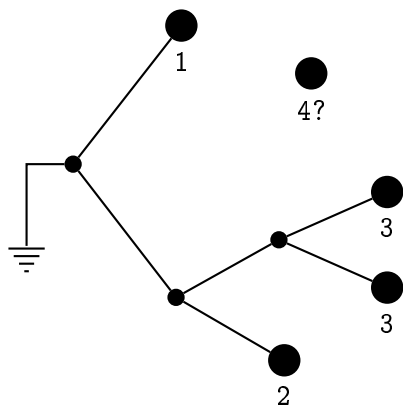
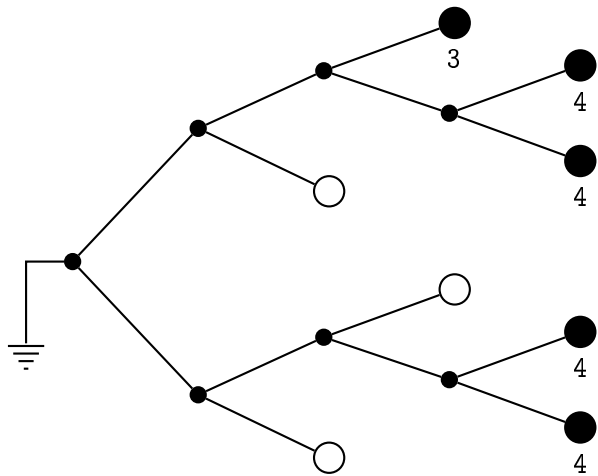

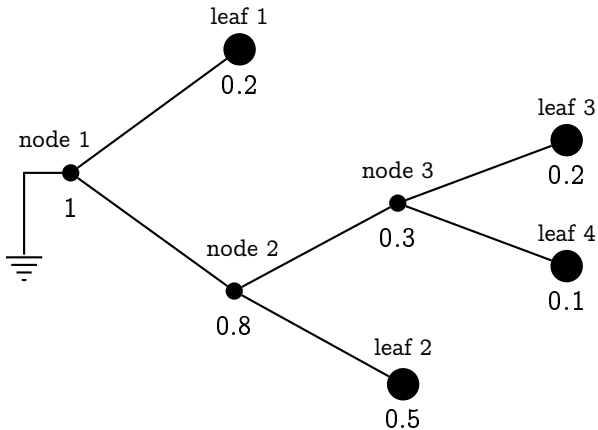

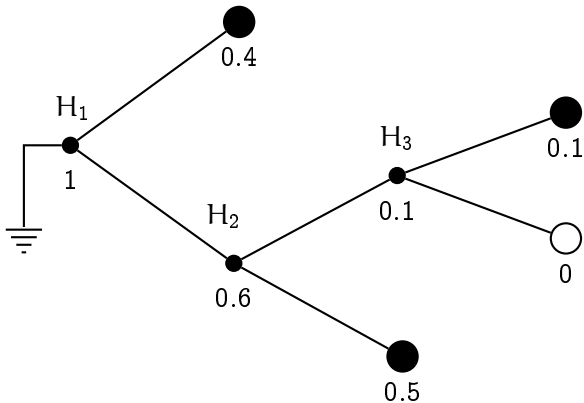

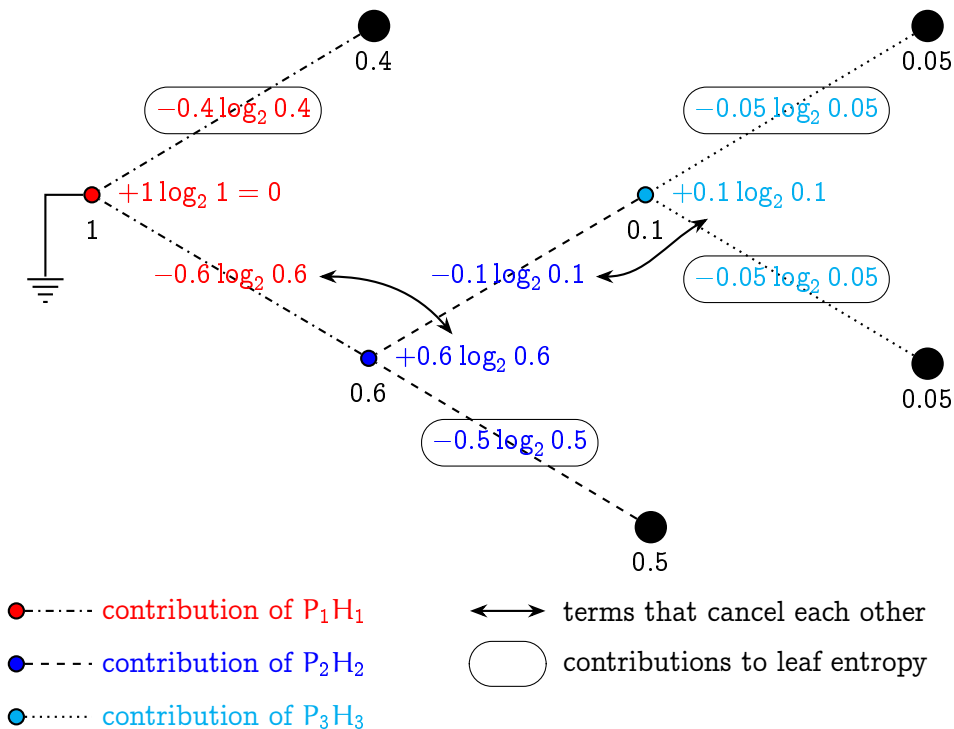

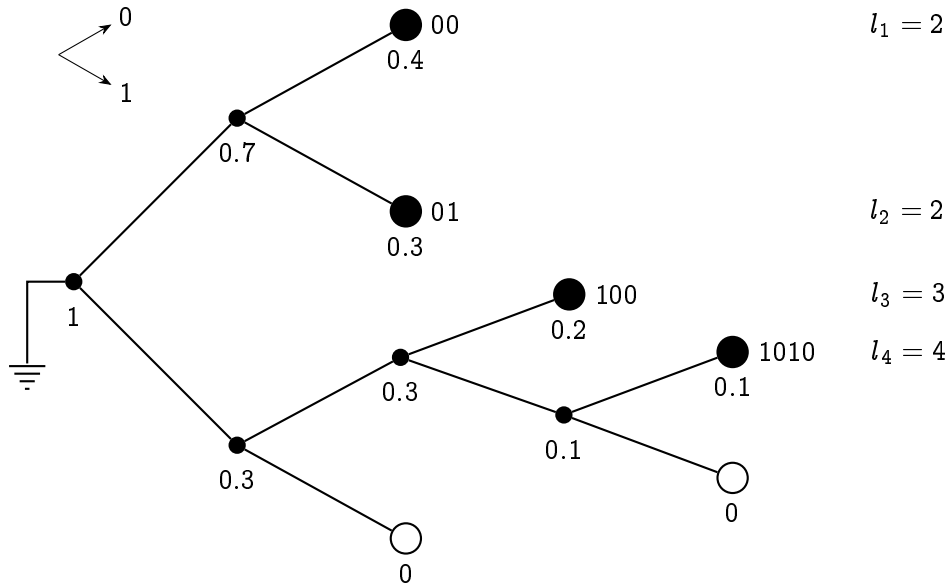

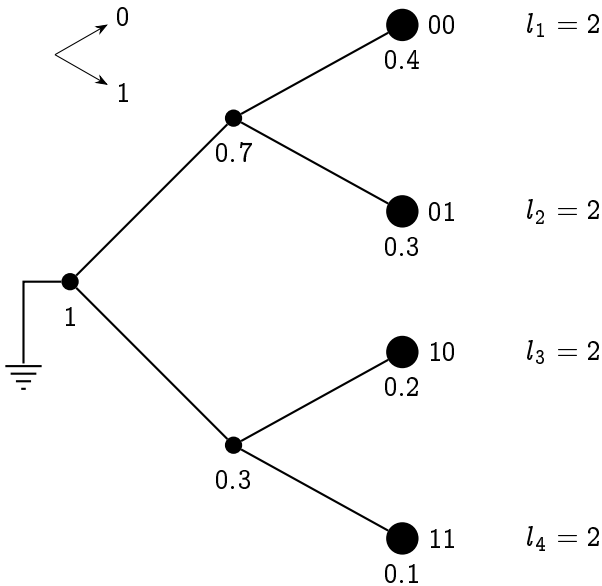

	$u_1$	$u_2$	$u_3$	$u_4$
$p_i$	0.4	0.3	0.2	0.1
$F_i$	0	0.4	0.7	0.9
binary representation	0.0	0.01100...	0.10110...	0.11100...
$\left\lceil \log_2 \frac{1}{p_i} \right\rceil$	2	2	3	4
shortened representation	0.00	0.01	0.101	0.1110
$c_i$	00	01	101	1110



---

	$u_1$	$u_2$	$u_3$	$u_4$
$p_i$	0.4	0.3	0.2	0.1
$F_i$	0	0.4	0.7	0.9
ternary representation	0.0	0.10121...	0.20022...	0.22002...
$\left\lceil \log_3 \frac{1}{p_i} \right\rceil$	1	2	2	3
shortened representation	0.0	0.10	0.20	0.220
$\mathbf{c}_i$	0	10	20	220

---

$p_1$	$p_2$	$p_3$	$p_4$	$p_5$
0.35	0.25	0.15	0.15	0.1
0.6		0.4		
0		1		
0.35	0.25	0.15	0.15	0.1
0		0.15	0.25	
1		0	1	
		0.15		0.1
		0		1
00	01	10	110	111

$p_1$	$p_2$	$p_3$	$p_4$	$p_5$
0.35	0.25	0.15	0.15	0.1
0.35	0.25	0.4		
<b>0</b>	<b>1</b>	<b>2</b>		
		0.15	0.15	0.1
		<b>0</b>	<b>1</b>	<b>2</b>
<b>0</b>	<b>1</b>	<b>20</b>	<b>21</b>	<b>22</b>

$p_1$	$p_2$	$p_3$	$p_4$	$p_5$	$p_6$	$p_7$
0.35	0.3	0.15	0.05	0.05	0.05	0.05
0.65 0		0.35 1				
0.35	0.3	0.15	0.05	0.05	0.05	0.05
0	1	0.2 0		0.15 1		
		0.15	0.05	0.05	0.05	0.05
		0	1	0.1 0		0.05
				0.05	0.05	
0	1	0.05		1		
00	01	100	101	1100	1101	111

$p_1$	$p_2$	$p_3$	$p_4$	$p_5$	$p_6$	$p_7$
0.35	0.3	0.15	0.05	0.05	0.05	0.05
0.35 0	0.65 1					
	0.3	0.15	0.05	0.05	0.05	0.05
	0.3 0	0.35 1				
		0.15	0.05	0.05	0.05	0.05
	0.15 0	0.2 1				
		0.05	0.05	0.05	0.05	0.05
0.1 0		0.1 1				
0.05	0.05	0.05	0.05	0.05	0.05	
0	1	0	1	0	1	
<b>0</b>	<b>10</b>	<b>110</b>	<b>11100</b>	<b>11101</b>	<b>11110</b>	<b>11111</b>

$p_1$	$p_2$	$p_3$	$p_4$	$p_5$	$p_6$	$p_7$	
0.35	0.3	0.15	0.05	0.05	0.05	0.05	
0.35 0	0.65 1						
	0.3	0.15	0.05	0.05	0.05	0.05	
	0.3 0	0.35 1					
		0.15	0.05	0.05	0.05	0.05	
	0.2 0			0.15 1			
	0.15	0.05	0.05	0.05	0.05		
	0	1	0.1 0				0.05 1
			0.05	0.05			
			0	1			
	0	10	1100	1101	11100	11101	1111

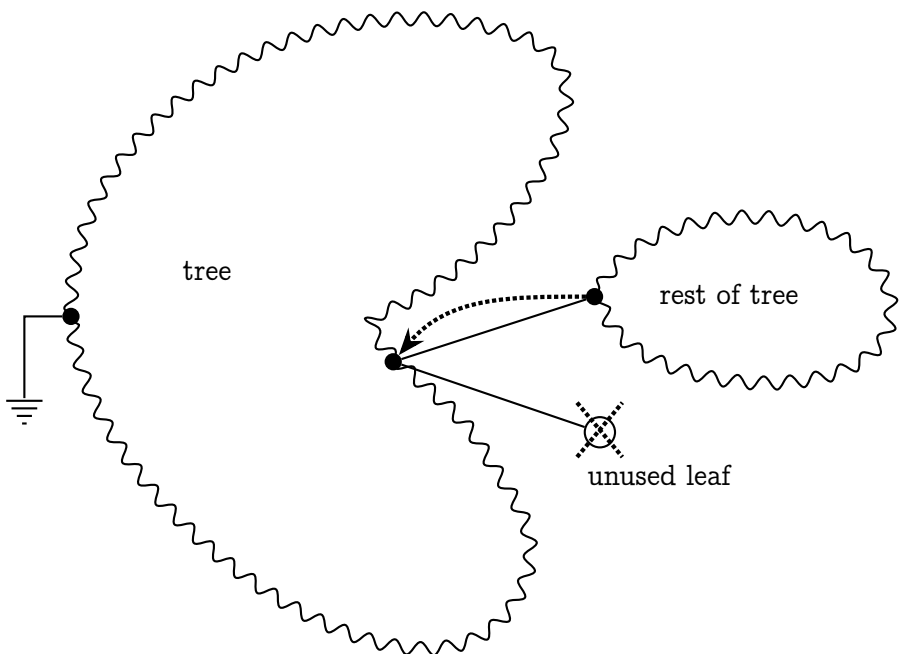

(i)

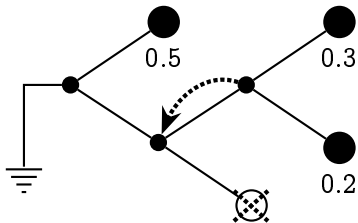

(ii)

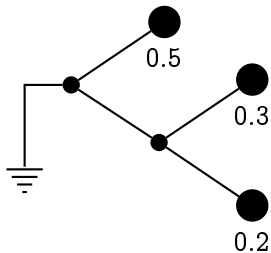





Step 1

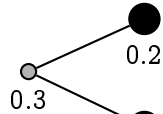

Step 2, first time

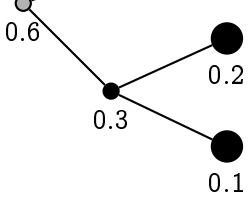

Step 2, second time

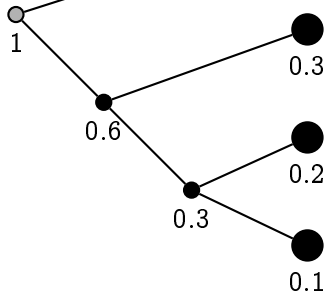
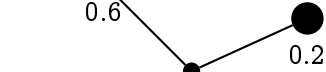
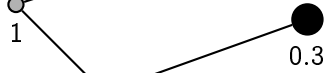

Step 2, third time

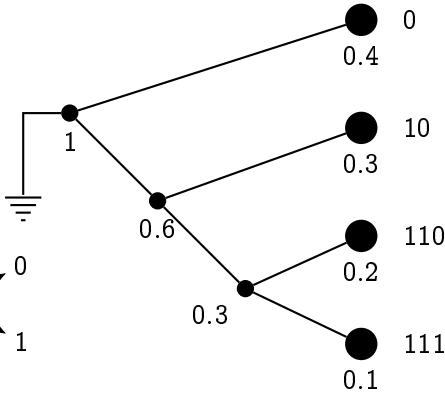

Step 3

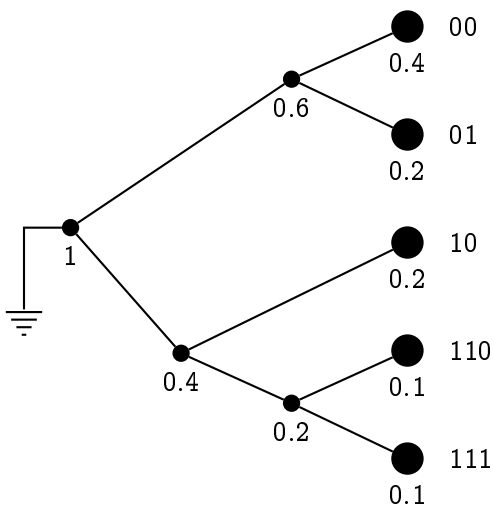
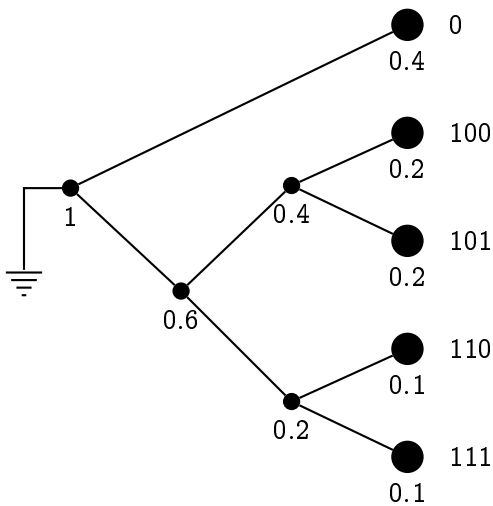
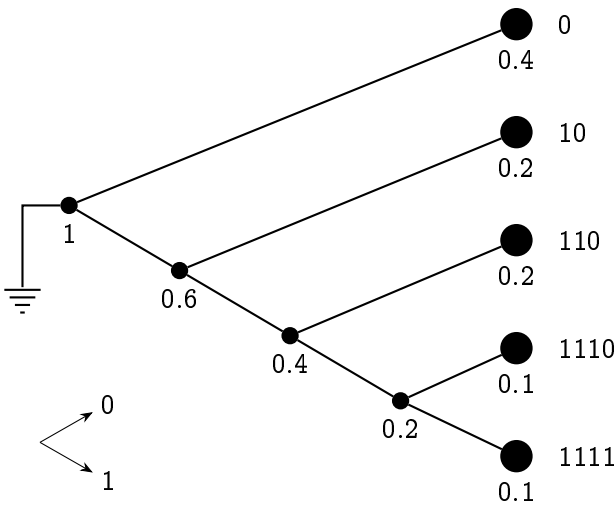

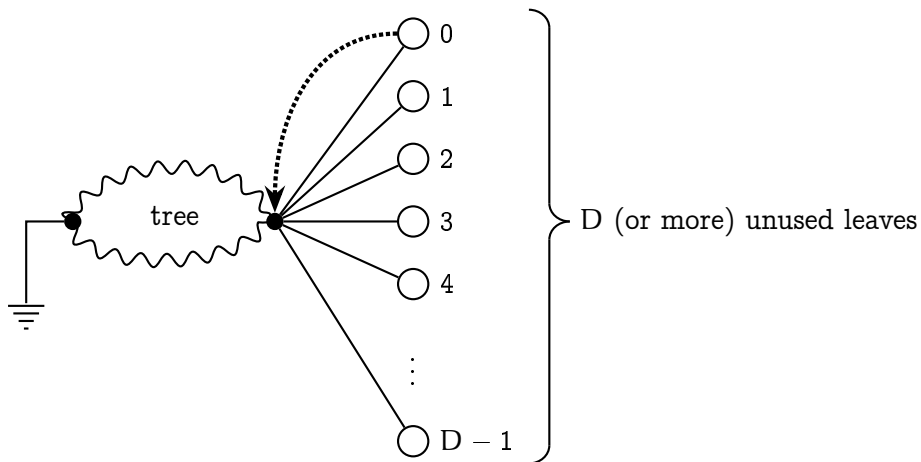
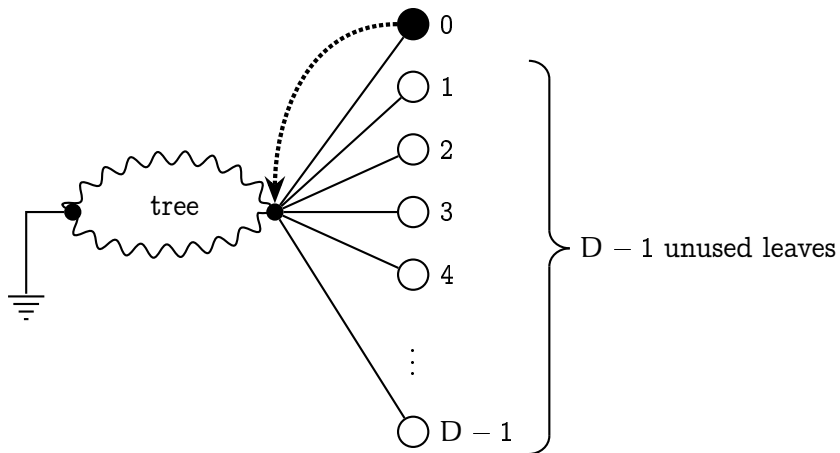

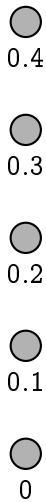

Step 1

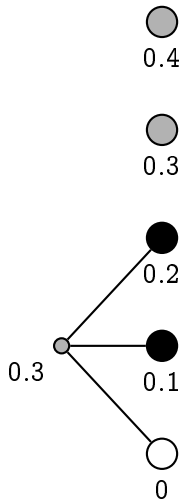

Step 2, first time

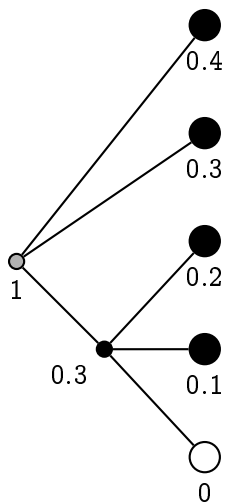

Step 2, second time

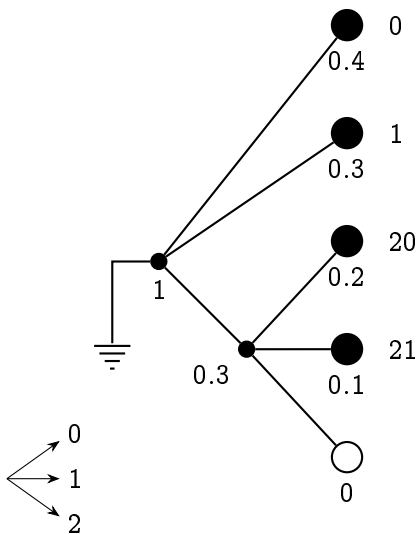

Step 3

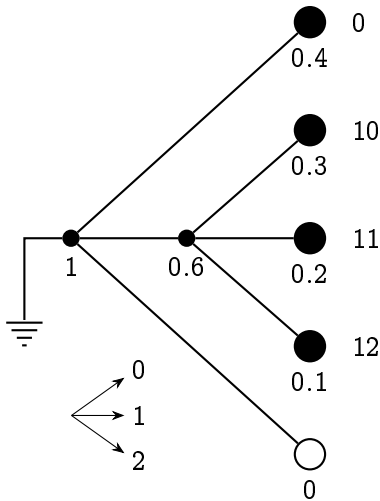

$p_1$	$p_2$	$p_3$	$p_4$	$p_5$	$p_6$	$p_7$
0.4	0.1	0.1	0.1	0.1	0.1	0.1
0.5 0		0.5 1				
0.4	0.1	0.1	0.1	0.1	0.1	0.1
0	1	0.2 0		0.3 1		
		0.1	0.1	0.1	0.1	0.1
		0	1	0.2 0		0.1 1
				0.1	0.1	
				0	1	
00	01	100	101	1100	1101	111

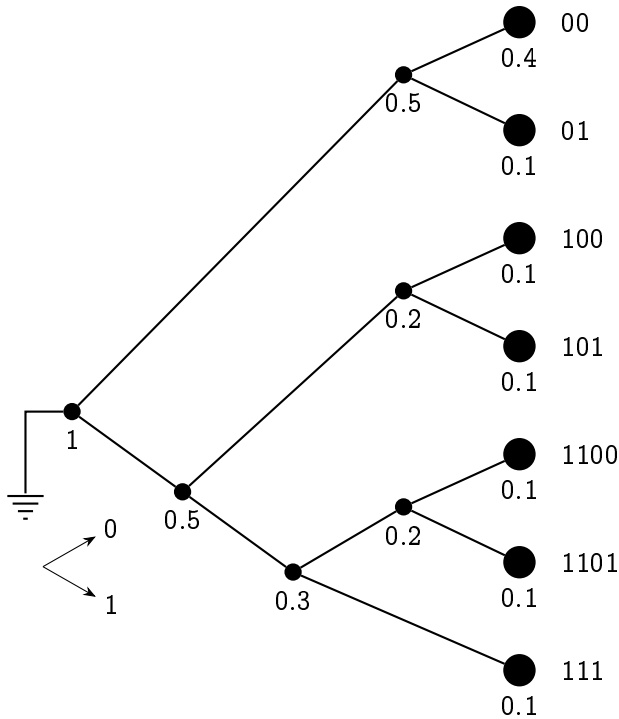

	$u_1$	$u_2$	$u_3$	$u_4$	$u_5$	$u_6$	$u_7$
$p_i$	0.4	0.1	0.1	0.1	0.1	0.1	0.1
$F_i$	0	0.4	0.5	0.6	0.7	0.8	0.9
binary representation	0.0	0.01100	0.1	0.10011	0.10110	0.11001	0.11100
$\left\lceil \log_2 \frac{1}{p_i} \right\rceil$	2	4	4	4	4	4	4
shortened representation	0.00	0.0110	0.1000	0.1001	0.1011	0.1100	0.1110
$c_i$	00	0110	1000	1001	1011	1100	1110



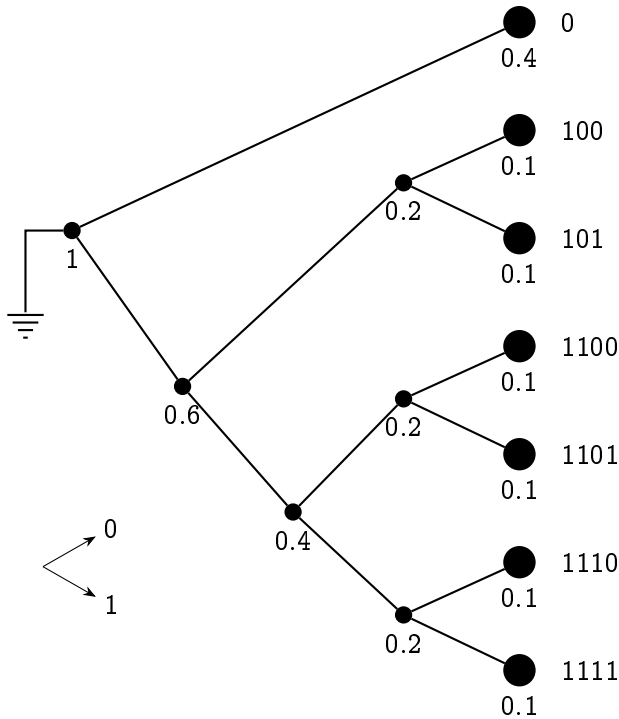

---

$U$	Code (i)	Code (ii)	Code (iii)	Code (iv)
$a$	0	0	10	0
$b$	0	010	00	10
$c$	1	01	11	110
$d$	1	10	110	111

---

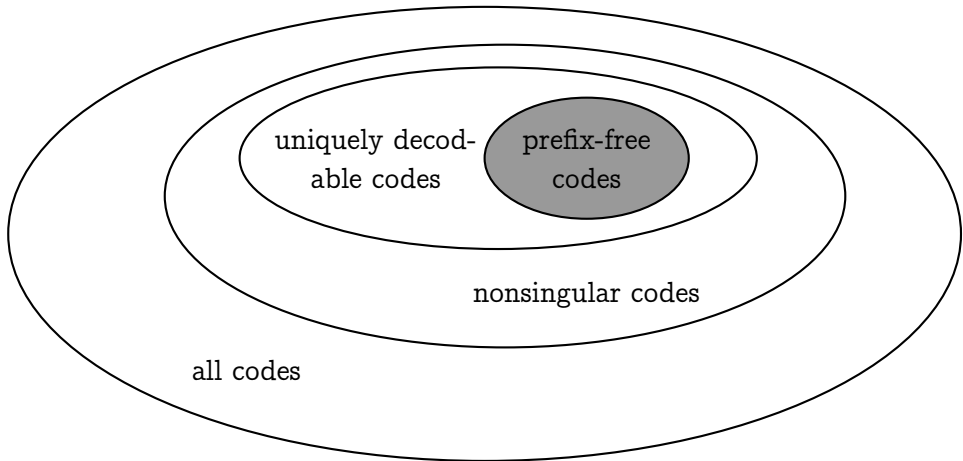

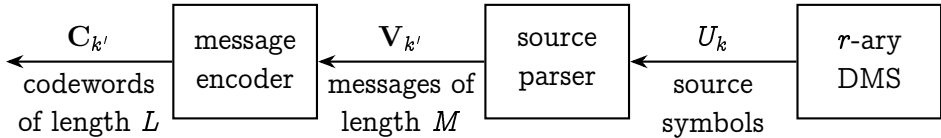

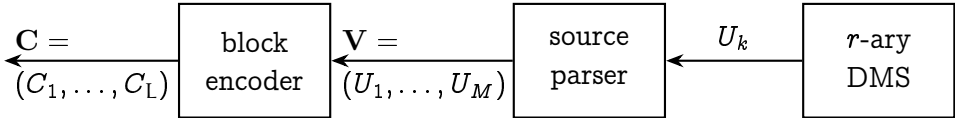

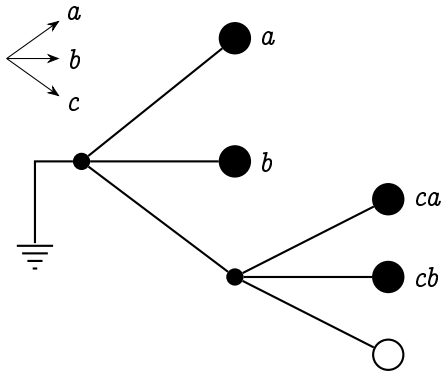

“illegal”

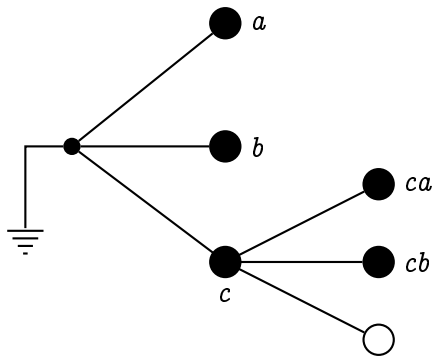

“legal”, but not proper

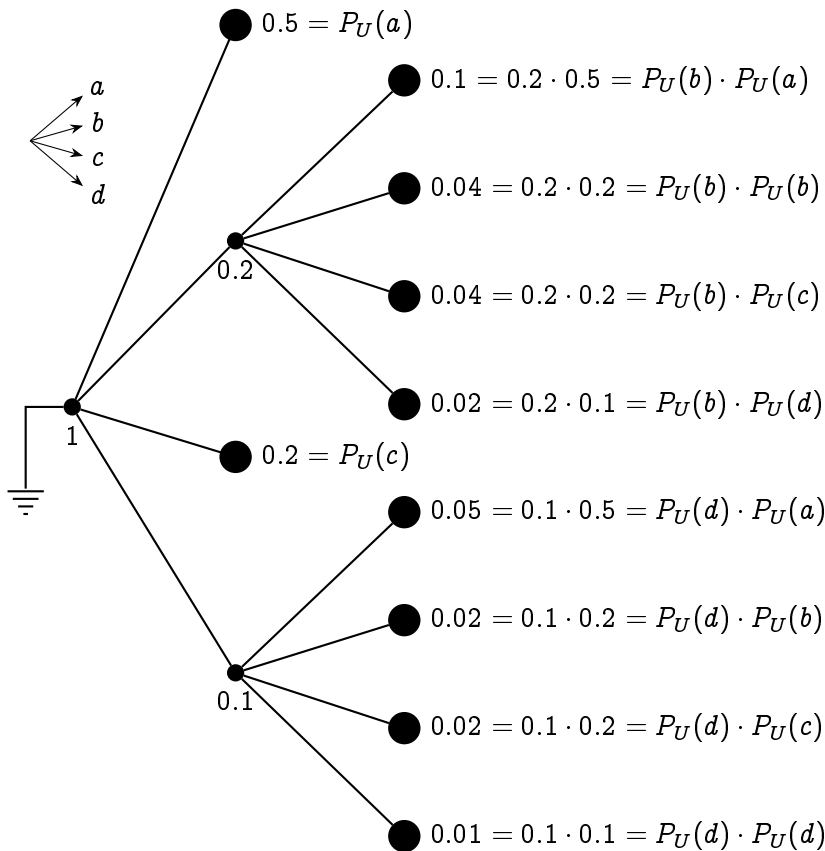

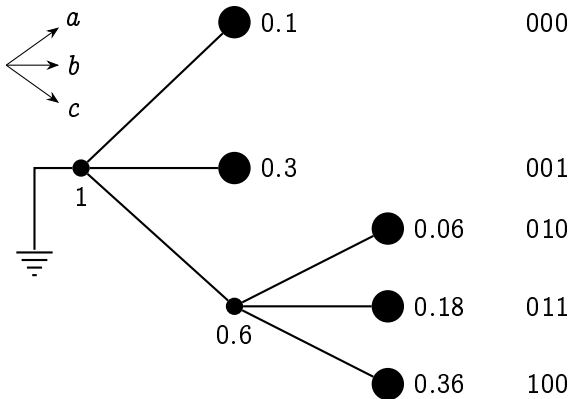



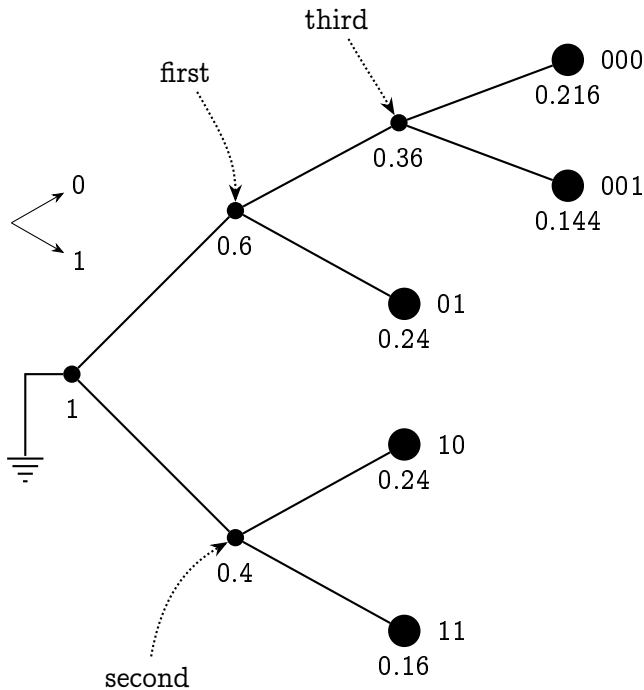

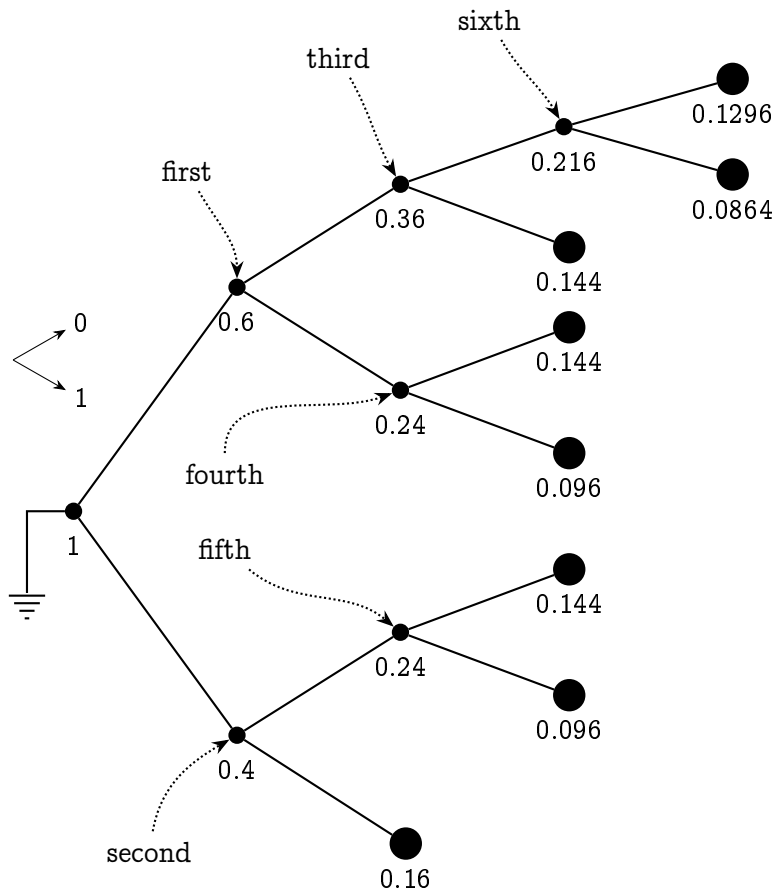

---

Message	Codewords
0000	000
0001	001
001	010
010	011
011	100
100	101
101	110
11	111

---

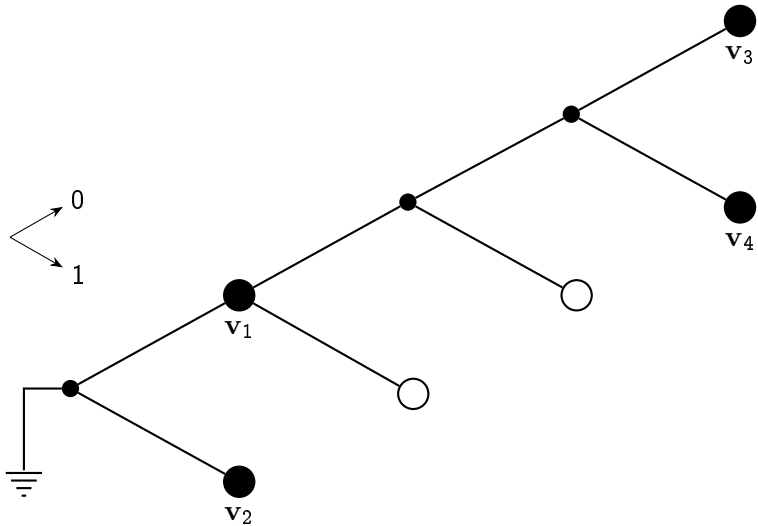

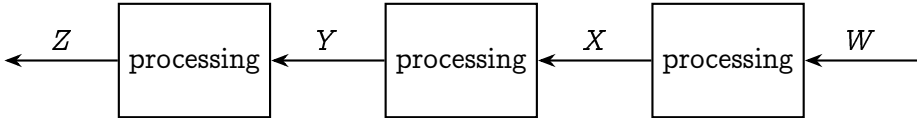

Stefan M. Moser, *Information Theory*, Version 6.15.

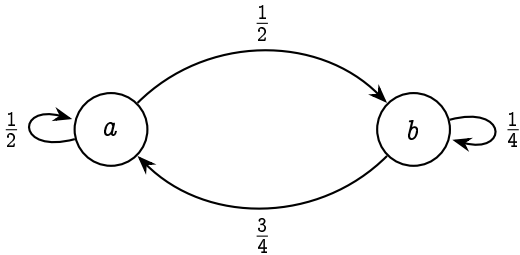

Stefan M. Moser, *Information Theory*, Version 6.15.

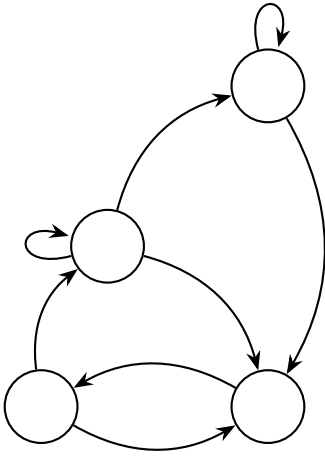

irreducible

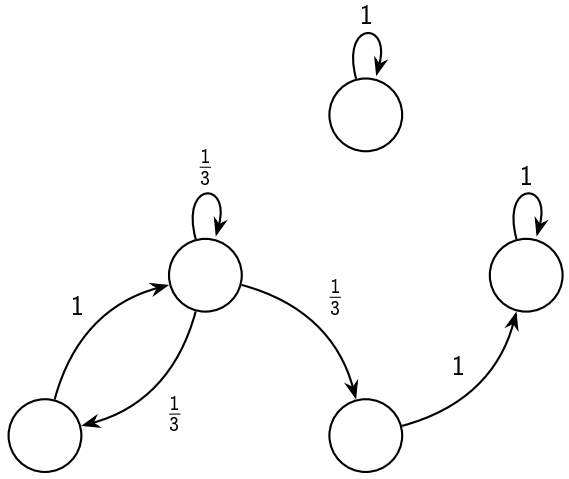

reducible

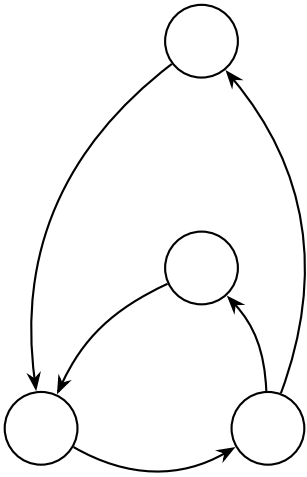

periodic

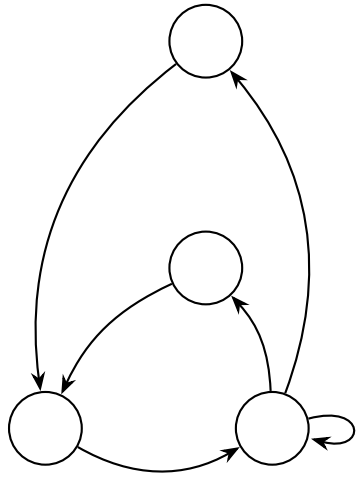

aperiodic

---

$P_{X_k}(\cdot)$	$k = 1$	$k = 2$	$k = 3$	$k = 4$
$\Pr[X_k = a]$	1	$\frac{1}{2} = 0.5$	$\frac{5}{8} = 0.625$	$\frac{19}{32} = 0.59375$
$\Pr[X_k = b]$	0	$\frac{1}{2} = 0.5$	$\frac{3}{8} = 0.375$	$\frac{13}{32} = 0.40625$

---

$P_{X_k}(\cdot)$	$k = 5$	...	$k = \infty$
$\Pr[X_k = a]$	$\frac{77}{128} = 0.6015625$	...	$\frac{3}{5} = 0.6$
$\Pr[X_k = b]$	$\frac{51}{128} = 0.3984375$	...	$\frac{2}{5} = 0.4$

---



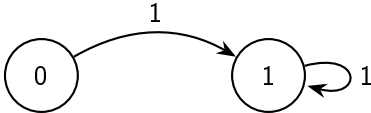

Stefan M. Moser, *Information Theory*, Version 6.15.

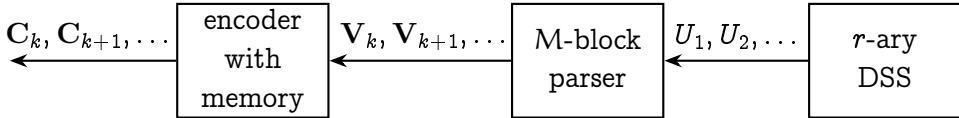

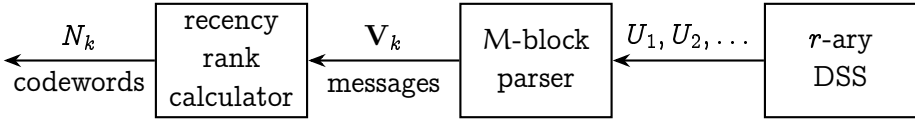

---

Message	Recency Rank at Time $k$
---------	--------------------------

---

00	4
----	---

01	1
----	---

10	3
----	---

11	2
----	---

---

---

Message	Recency Rank at Time $k + 1$
00	4
01	2
10	1
11	3

---

---

Message	Recency Rank at Time 1 (by definition)
---------	---

---

00	1
----	---

01	2
----	---

10	3
----	---

11	4
----	---

---

---

$n$	1	2	3	4	5	6	7	8	9	10	...
$B_0(n)$	1	10	11	100	101	110	111	1000	1001	1010	...

---

---

$n$	1	2	3	4	5	6
$B_0(n)$	1	10	11	100	101	110
$L_{B_0}(n) - 1$	0	1	1	2	2	2
$B_1(n)$	1	010	011	00100	00101	00110

---

$n$	7	8	9	10	11	...
$B_0(n)$	111	1000	1001	1010	1011	...
$L_{B_0}(n) - 1$	2	3	3	3	3	...
$B_1(n)$	00111	0001000	0001001	0001010	0001011	...

---



---

$n$	1	2	3	4	5	6
$B_0(n)$	1	10	11	100	101	110
$L_{B_0}(n)$	1	2	2	3	3	3
$B_1(L_{B_0}(n))$	1	010	010	011	011	011
$B_2(n)$	1	0100	0101	01100	01101	01110

---

$n$	7	8	9	10	11	...
$B_0(n)$	111	1000	1001	1010	1011	...
$L_{B_0}(n)$	3	4	4	4	4	...
$B_1(L_{B_0}(n))$	011	00100	00100	00100	00100	...
$B_2(n)$	01111	00100000	00100001	00100010	00100011	...

---

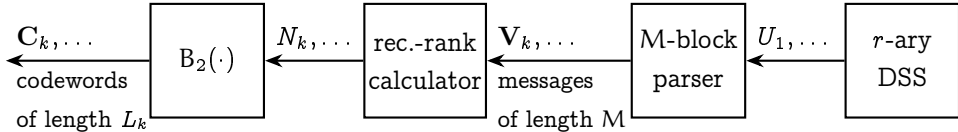

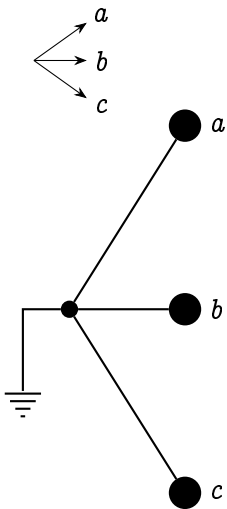

(a)

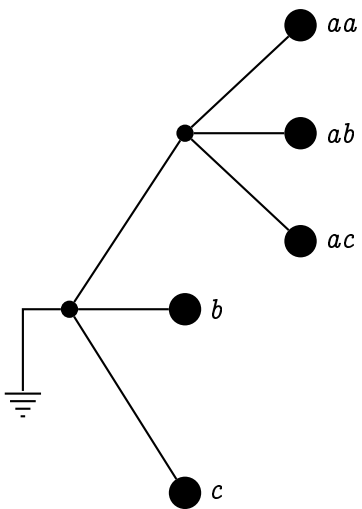

(b)

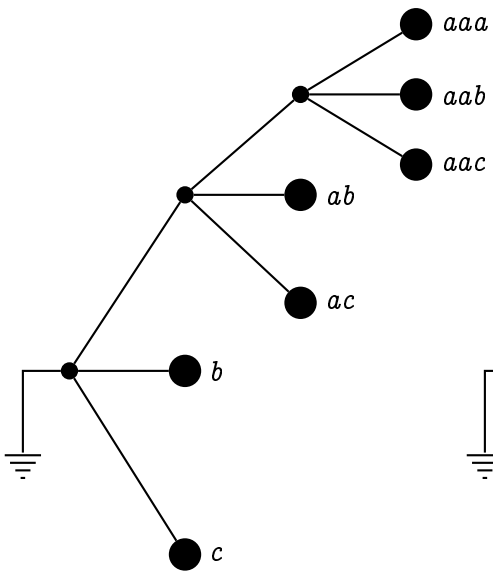

(c)

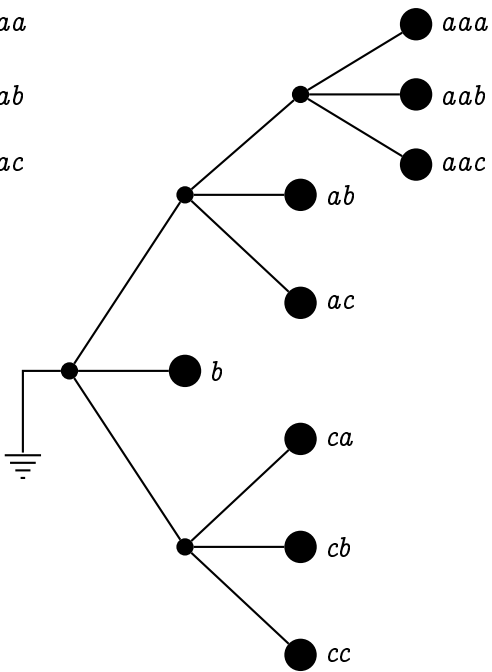

(d)

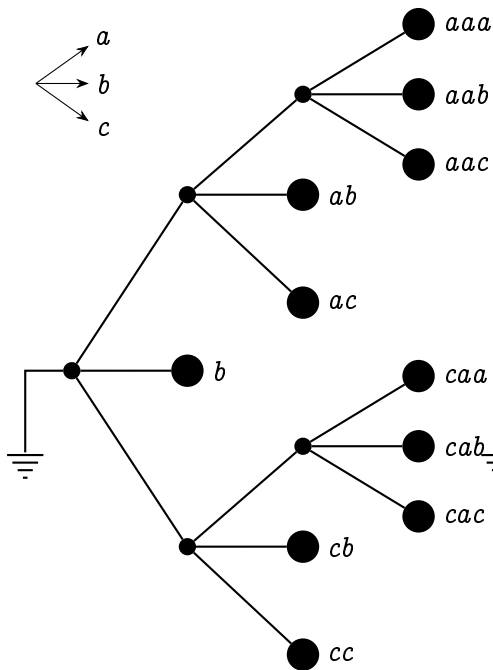

(e)

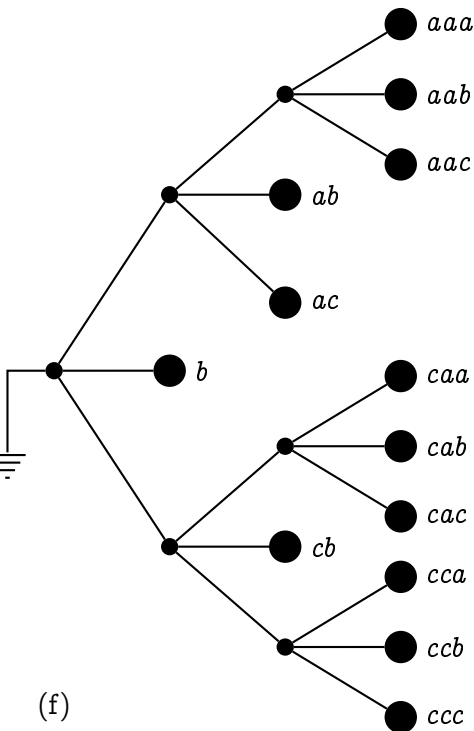

(f)

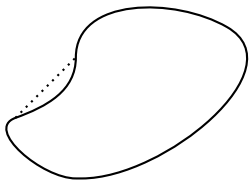

nonconvex

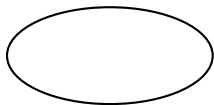

convex

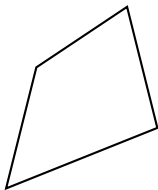

convex

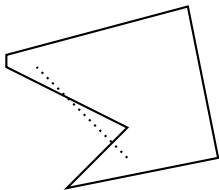

nonconvex

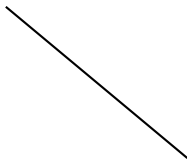

convex

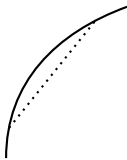

nonconvex

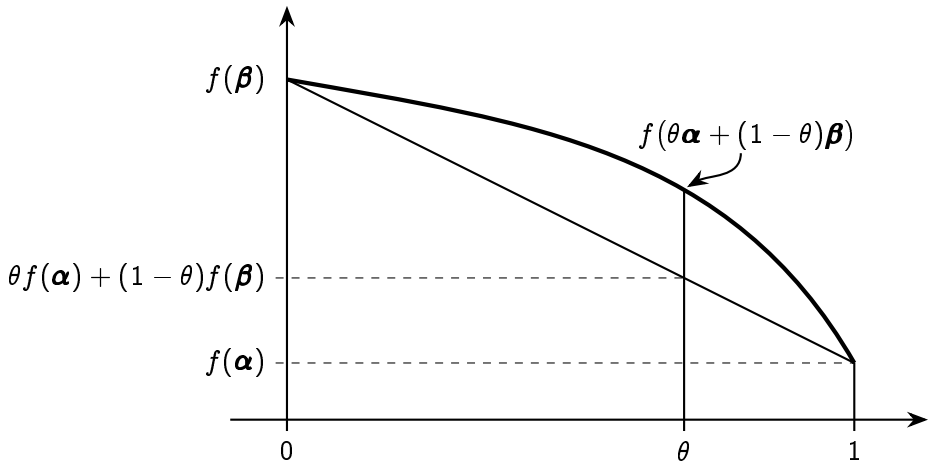

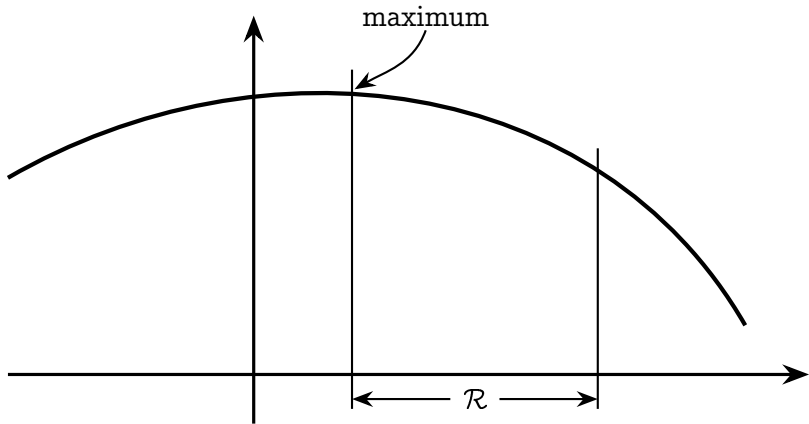

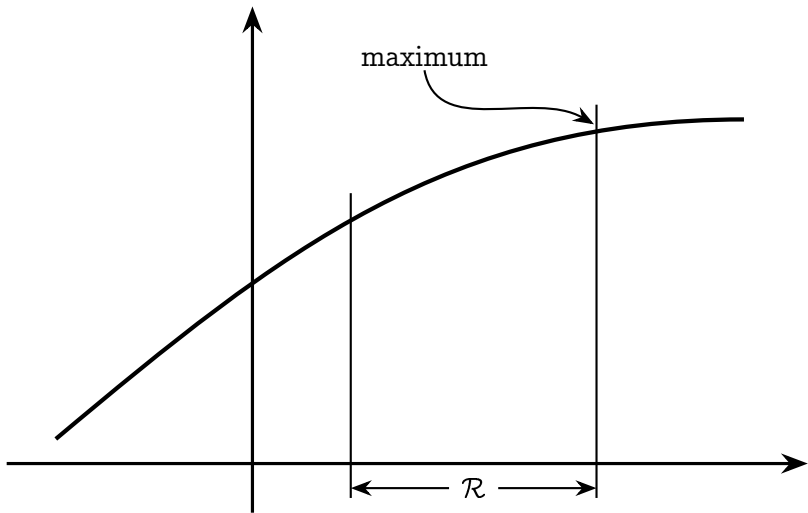



---

original name	2	3	1
new name $t$	1	2	3

---

$p_i$	0.2	0.1	0.7
$o_i$	6	10	1.2
$p_i o_i$	1.2	1.0	0.84
	$\vee$	$\vee$	$\wedge$
$\beta_t$	1	0.96	0.955

---

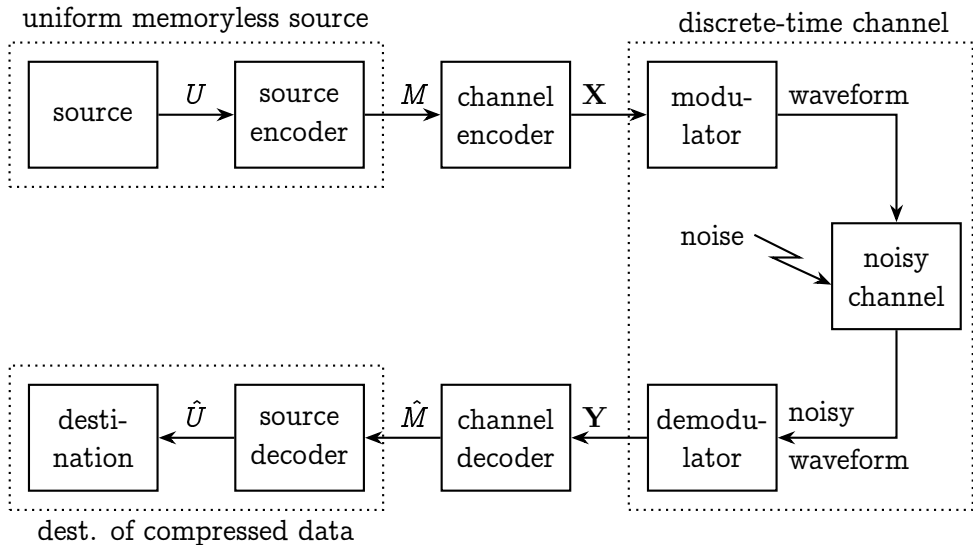

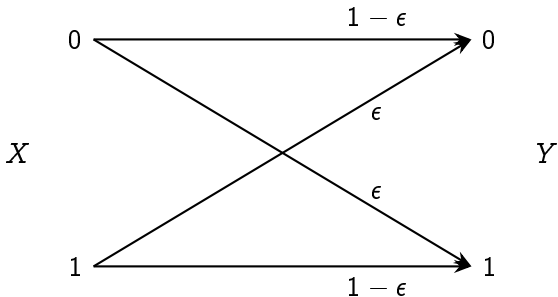

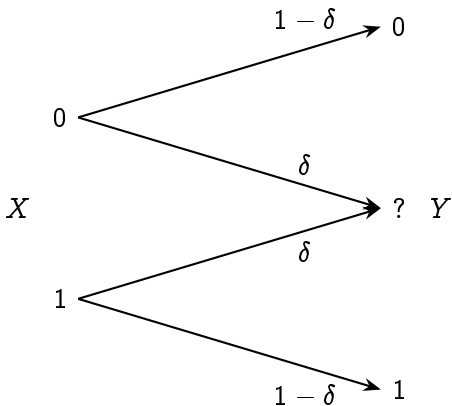

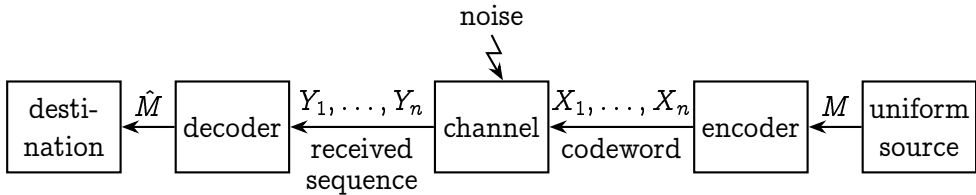

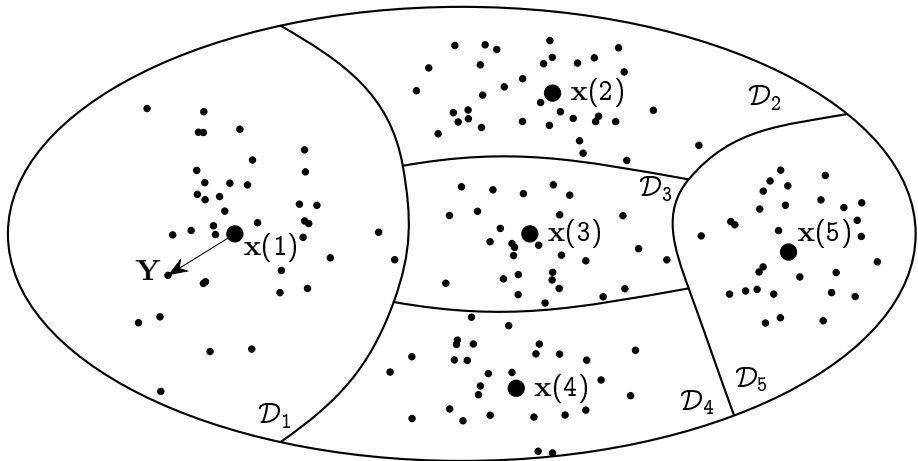

$X$

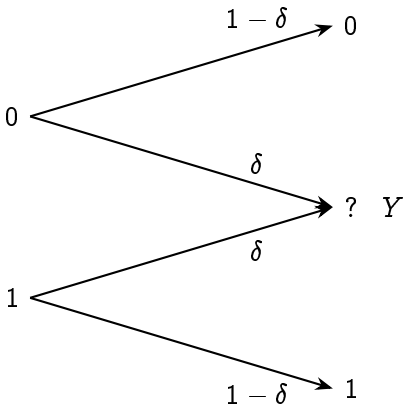

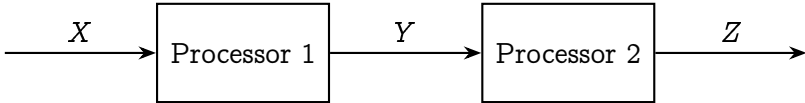

Stefan M. Moser, *Information Theory*, Version 6.15.



generate  $\mathbf{X}(1)$



send it  
through DMC



receive  $\mathbf{Y}$

independent



generate other  
codewords  $\mathbf{X}(m)$  using  
the same  $P_X(\cdot)$ ,  
but independently

independent

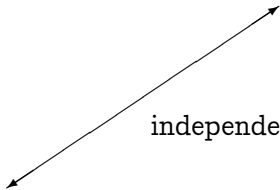

$|\mathcal{X}| = 2$

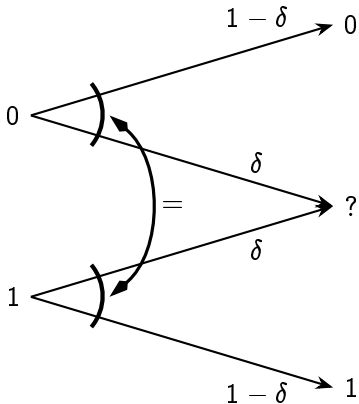

$|\mathcal{Y}| = 3$

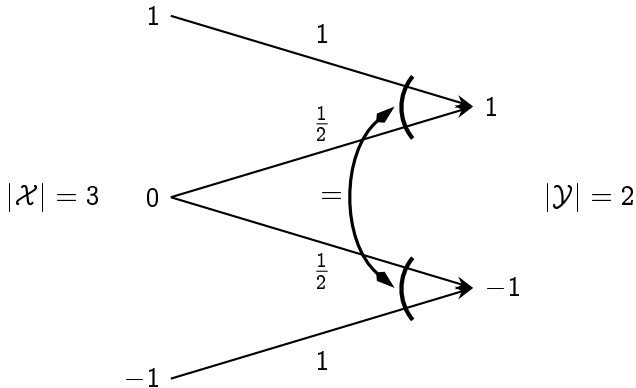

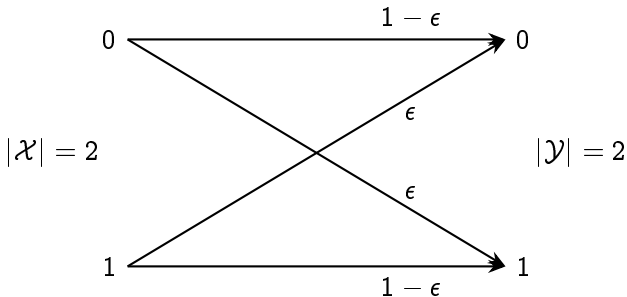

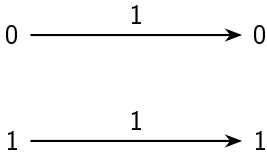
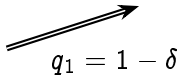
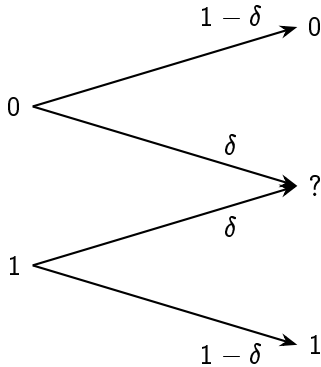

DMC 1

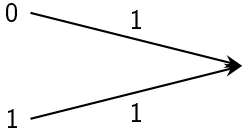
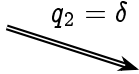

DMC 2

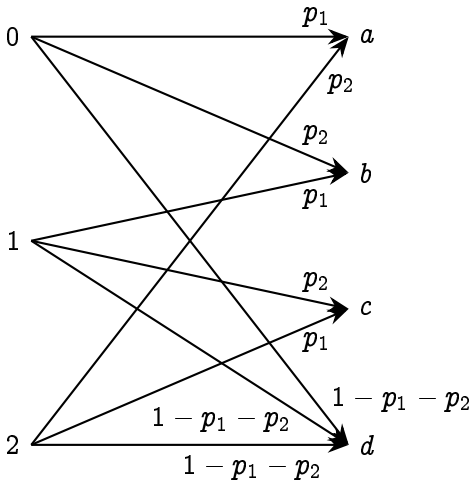

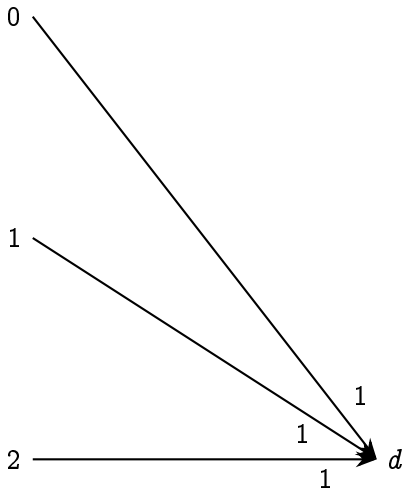
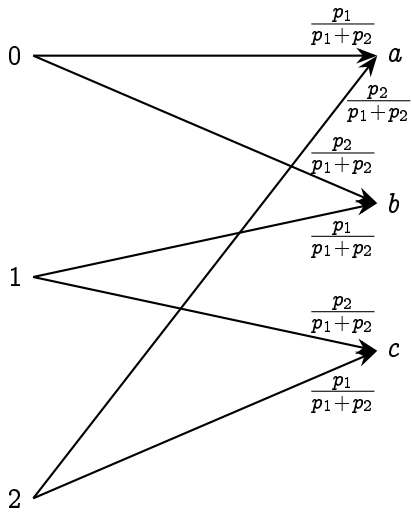

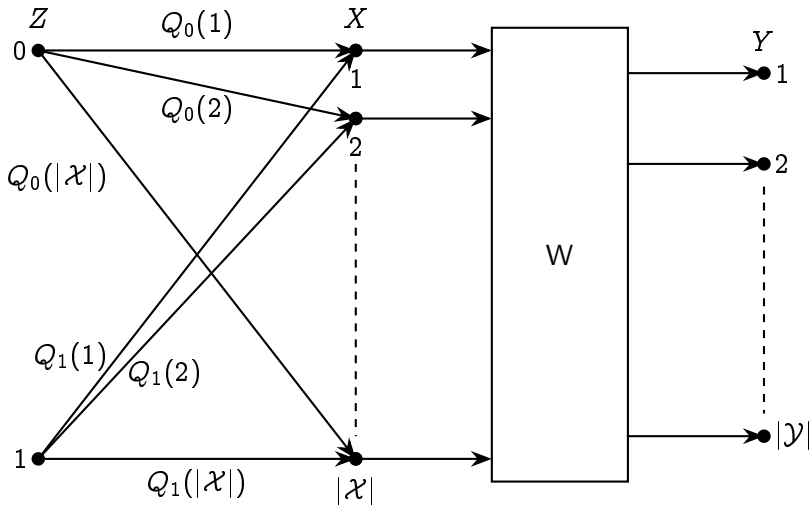



W

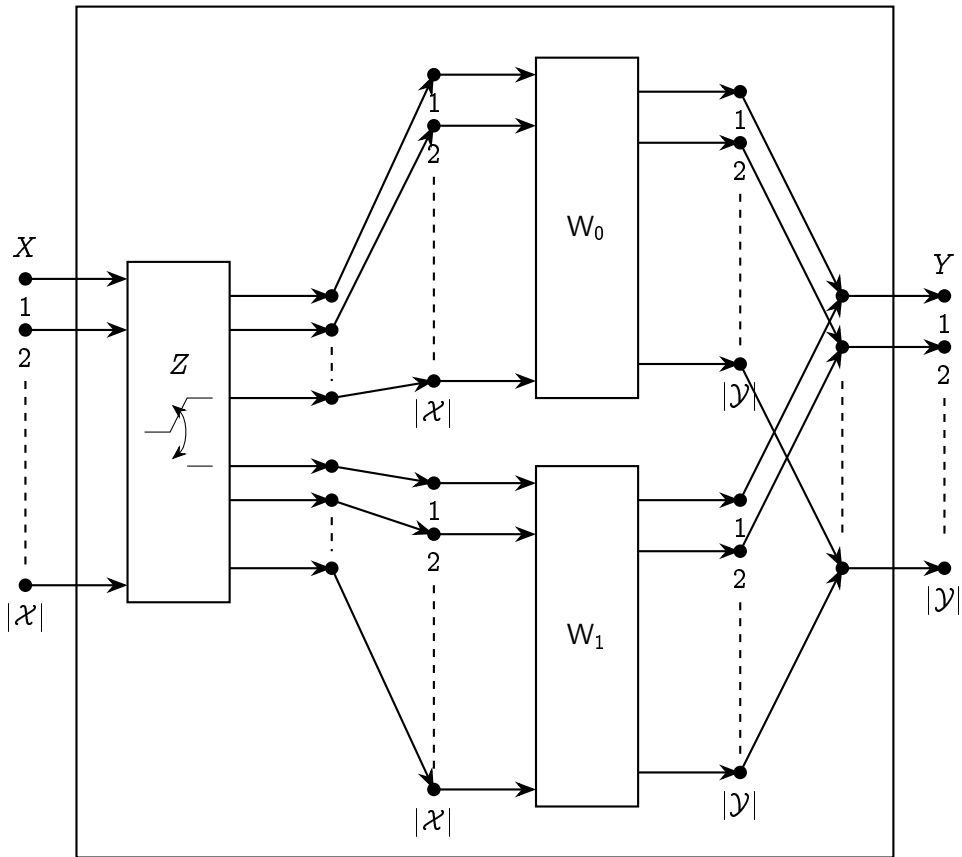

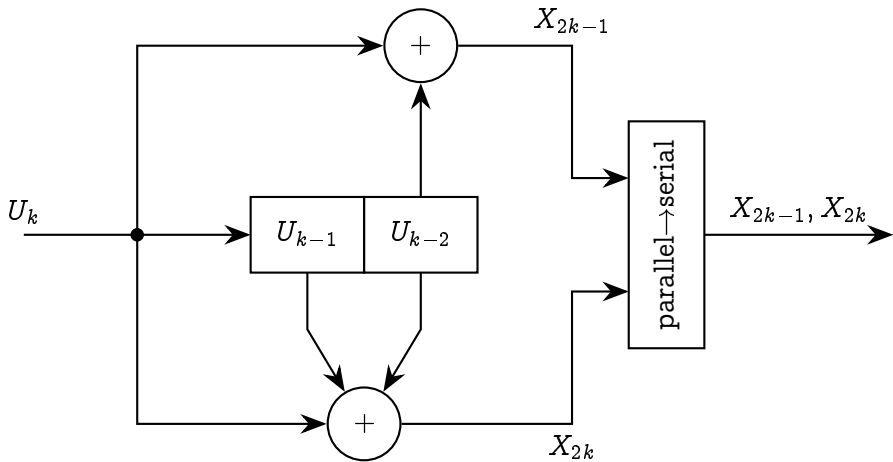

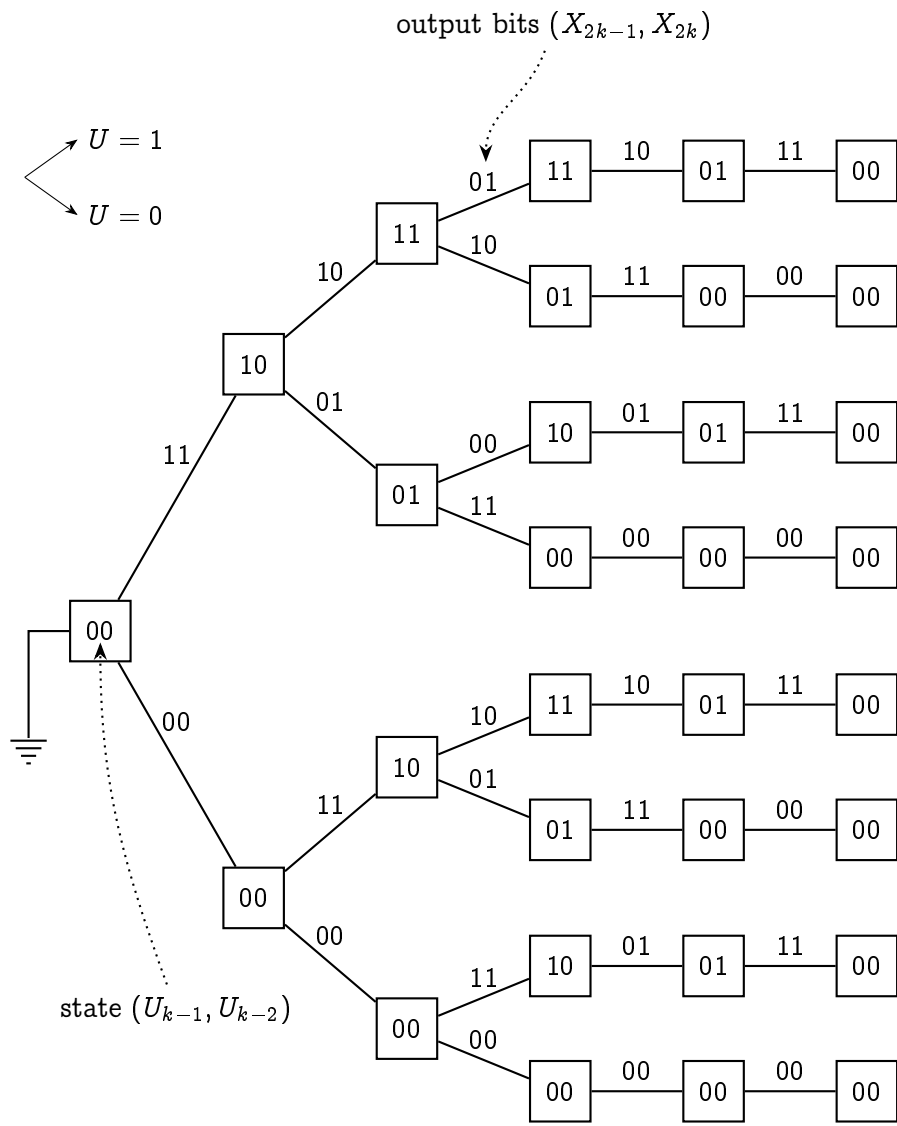

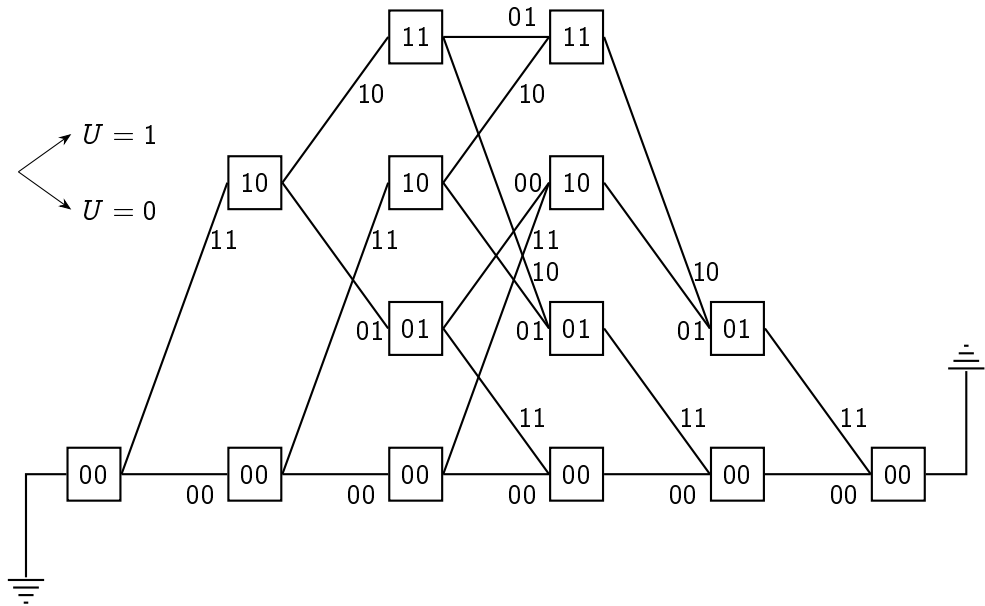

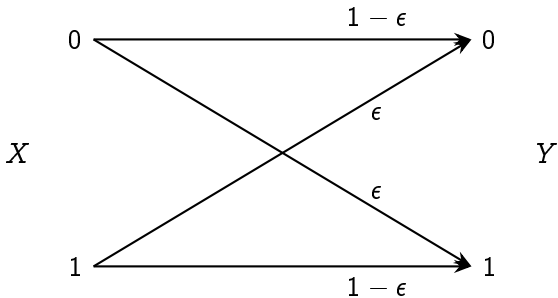

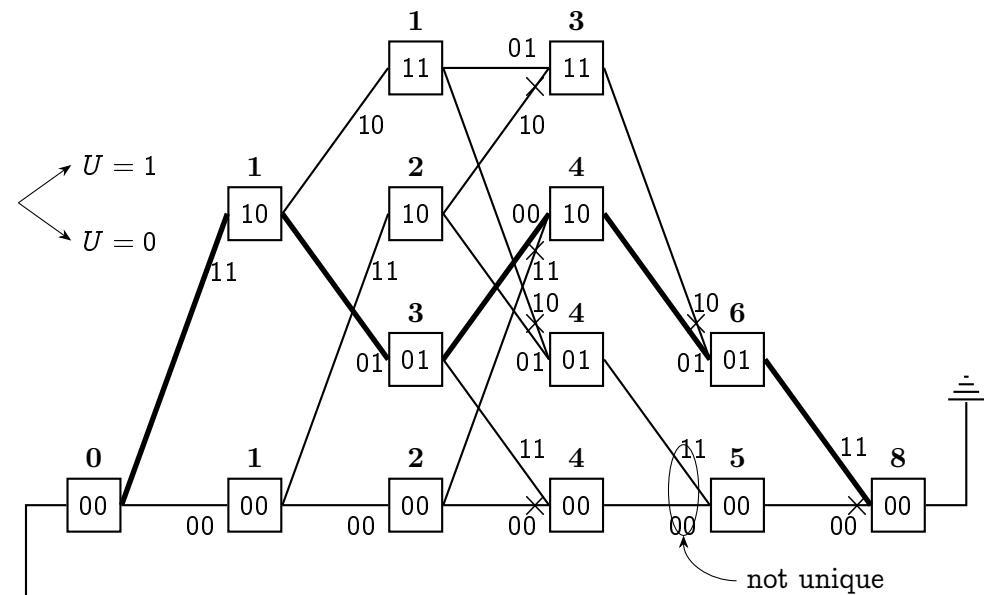

$\mathbf{y} =$	01	01	01	01	11
$\hat{\mathbf{x}} =$	11	01	00	01	11
$\hat{\mathbf{u}} =$	1	0	1		

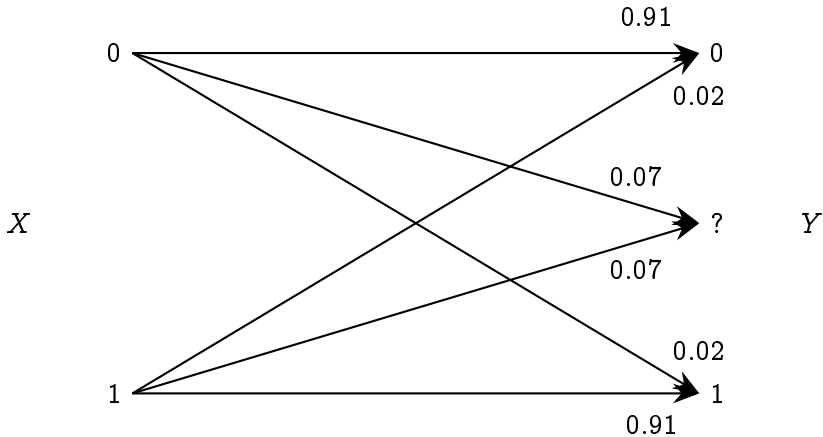

---

	$y = 0$	$y = ?$	$y = 1$
$x = 0$	$\log 0.91 - \log 0.02$ $\approx 5.50$	$\log 0.07 - \log 0.07$ $= 0$	$\log 0.02 - \log 0.02$ $= 0$
$x = 1$	$\log 0.02 - \log 0.02$ $= 0$	$\log 0.07 - \log 0.07$ $= 0$	$\log 0.91 - \log 0.02$ $\approx 5.50$

---



---

	$y = 0$	$y = ?$	$y = 1$
$x = 0$	1	0	0
$x = 1$	0	0	1

---

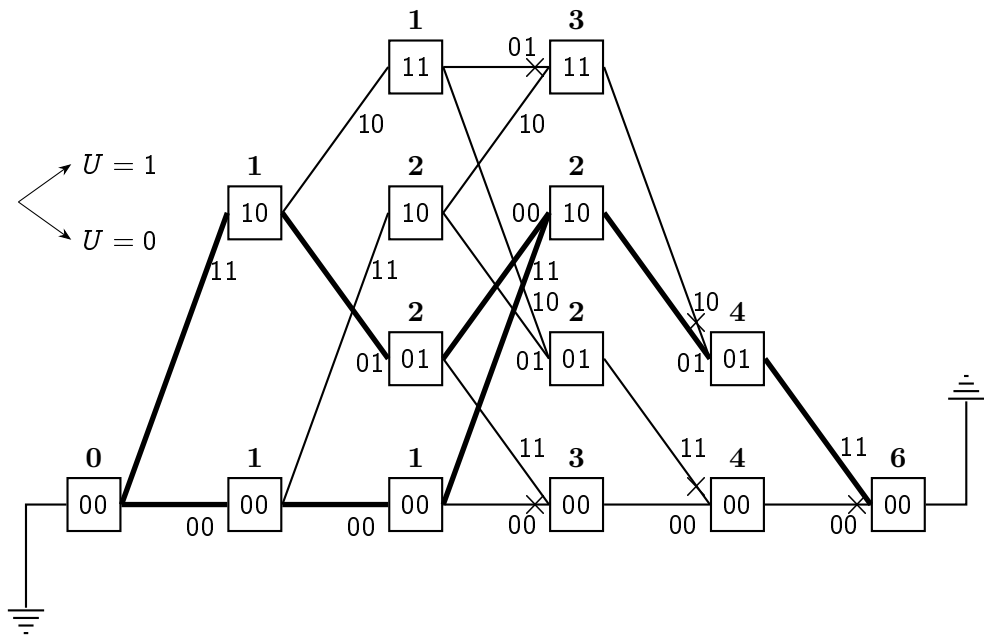

$\mathbf{y} =$	01	?1	1?	01	11
$\hat{\mathbf{x}} =$	11	01	00	01	11
	00	00	11	01	11
$\hat{\mathbf{u}} =$	1	0	1		
	0	0	1		

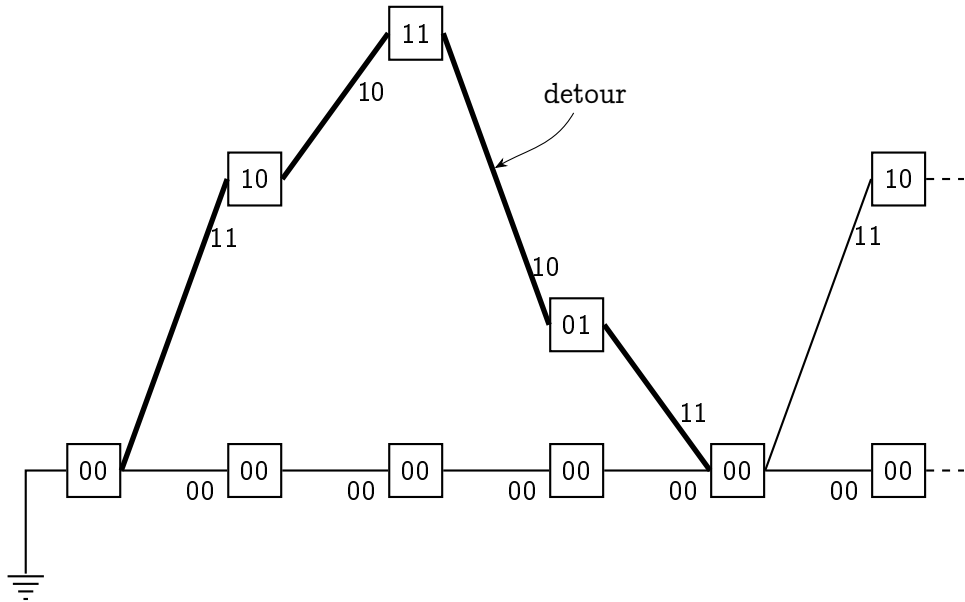

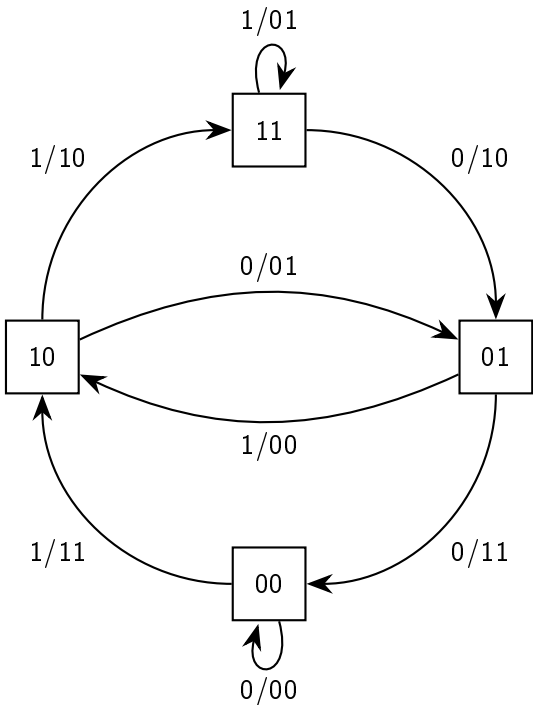

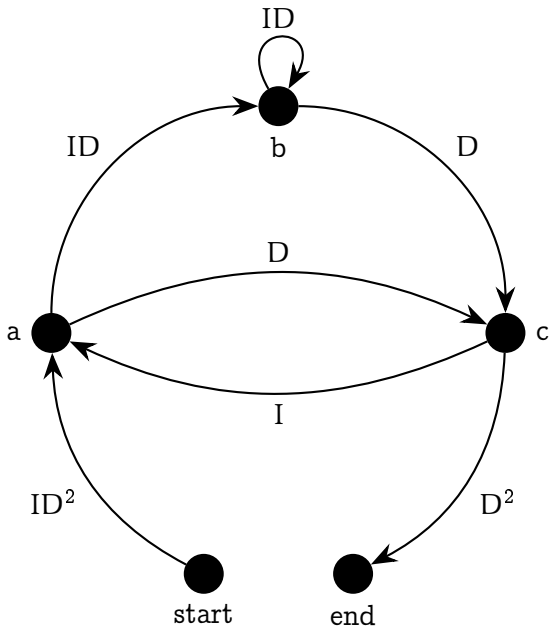

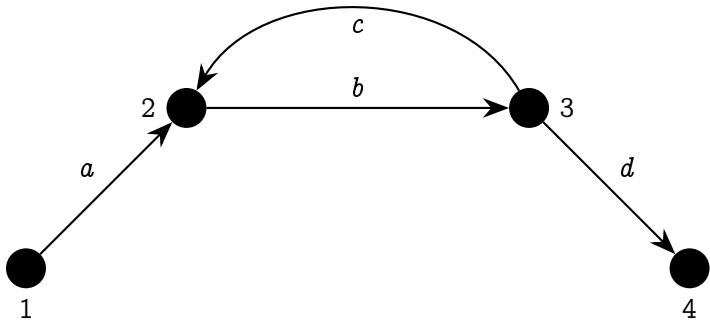

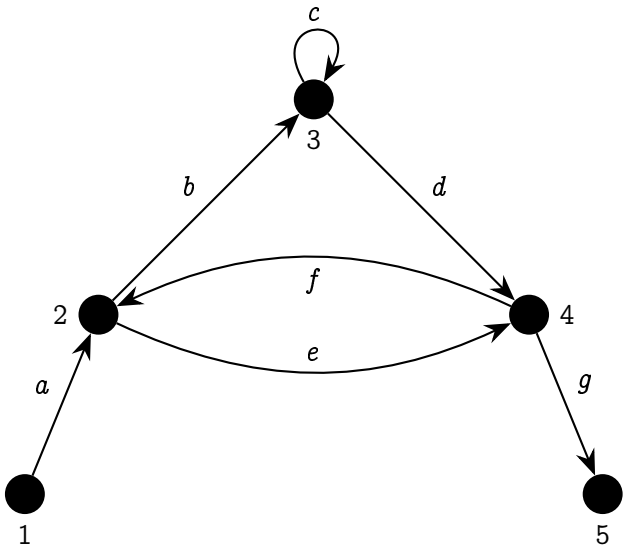

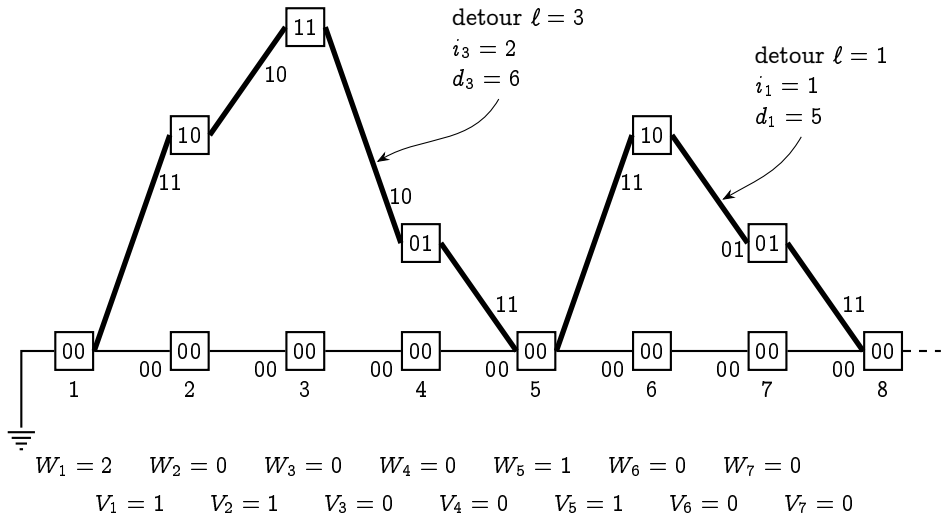



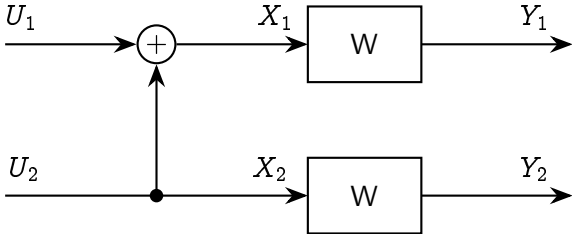

$X$

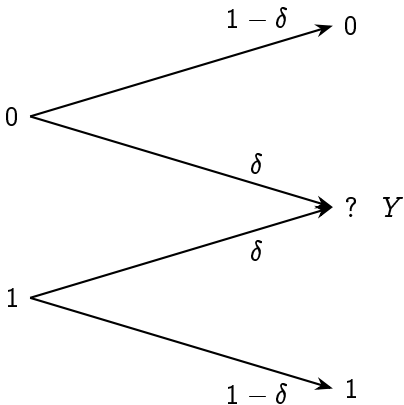

---

$y_1$	$y_2$	$W^-(y_1, y_2 0)$	$W^-(y_1, y_2 1)$
0	0	$(1 - \delta)^2/2$	0
0	?	$\delta(1 - \delta)/2$	$\delta(1 - \delta)/2$
0	1	0	$(1 - \delta)^2/2$
?	0	$\delta(1 - \delta)/2$	$\delta(1 - \delta)/2$
?	?	$\delta^2$	$\delta^2$
?	1	$\delta(1 - \delta)/2$	$\delta(1 - \delta)/2$
1	0	0	$(1 - \delta)^2/2$
1	?	$\delta(1 - \delta)/2$	$\delta(1 - \delta)/2$
1	1	$(1 - \delta)^2/2$	0

---

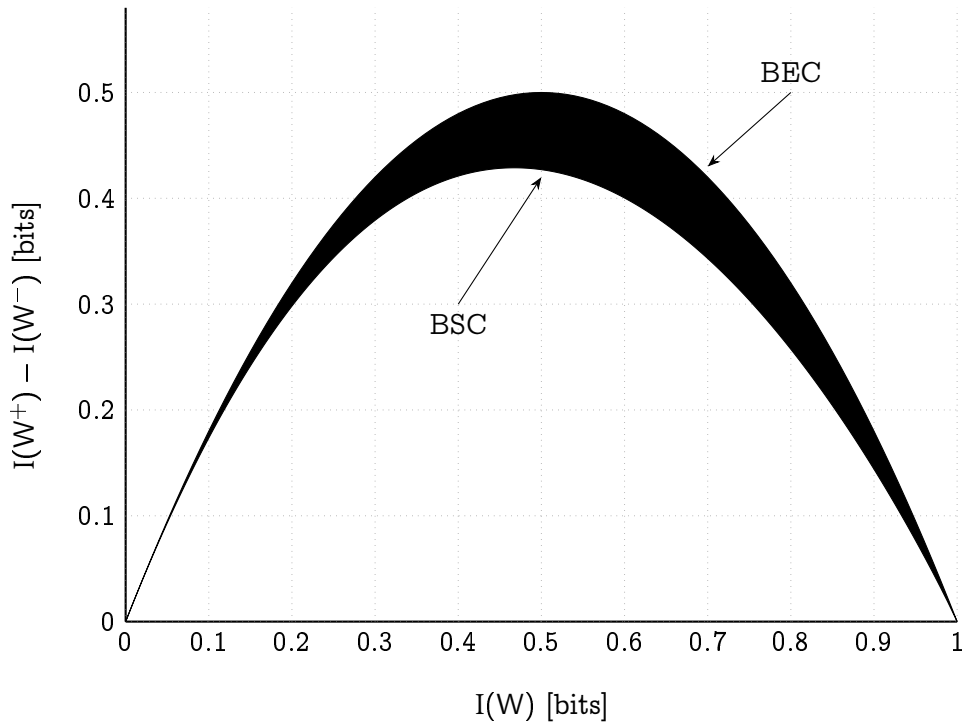

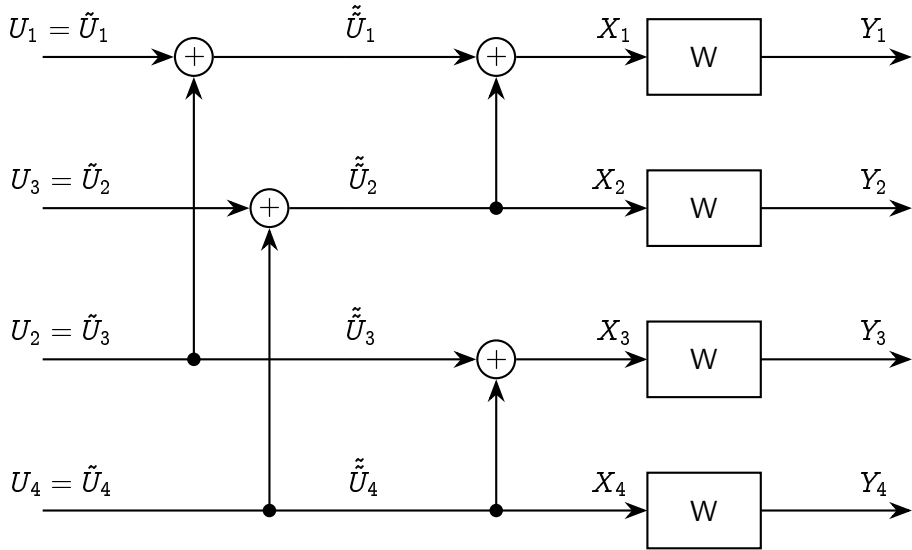

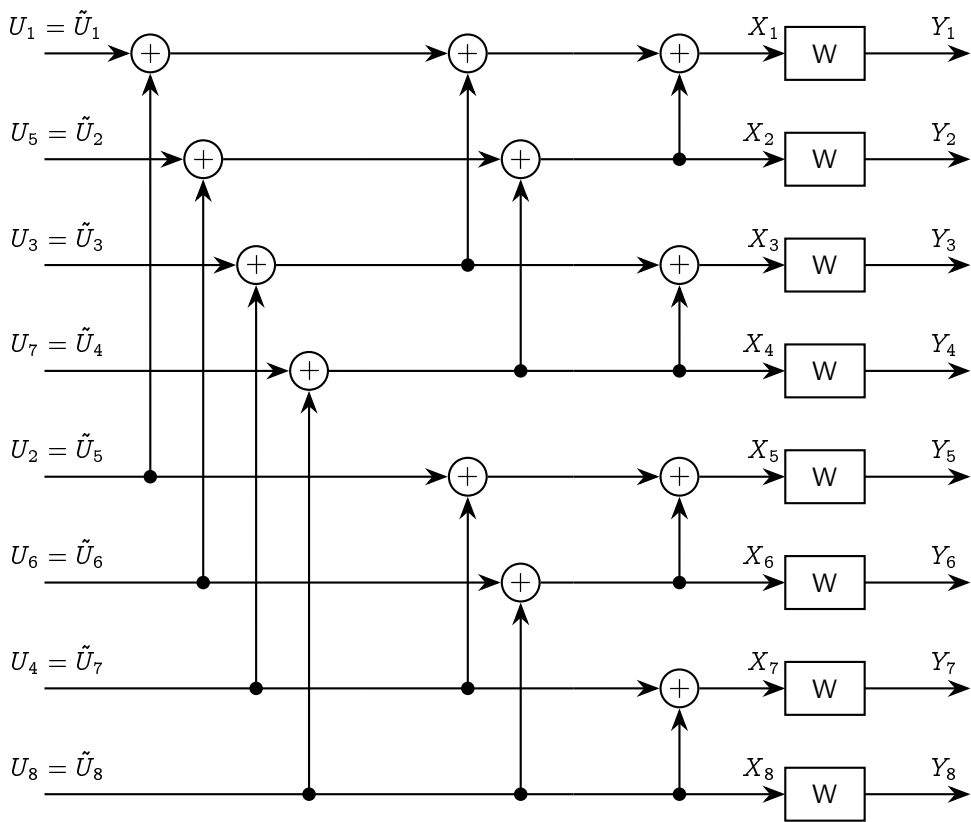

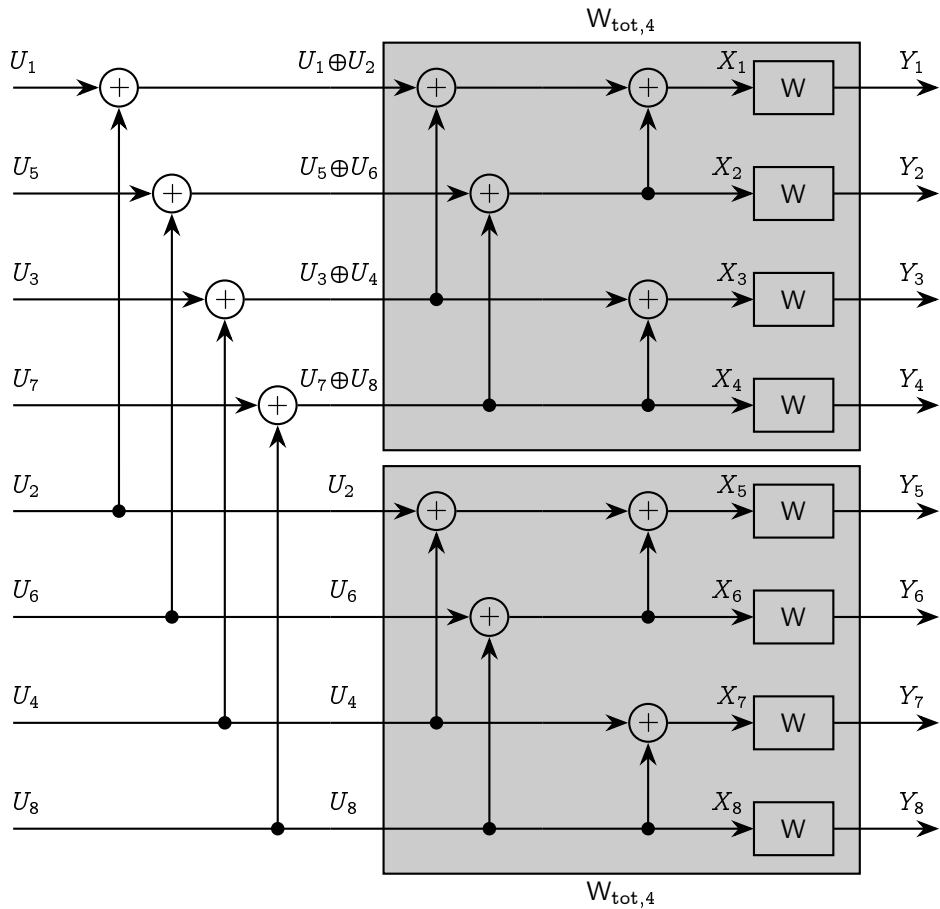

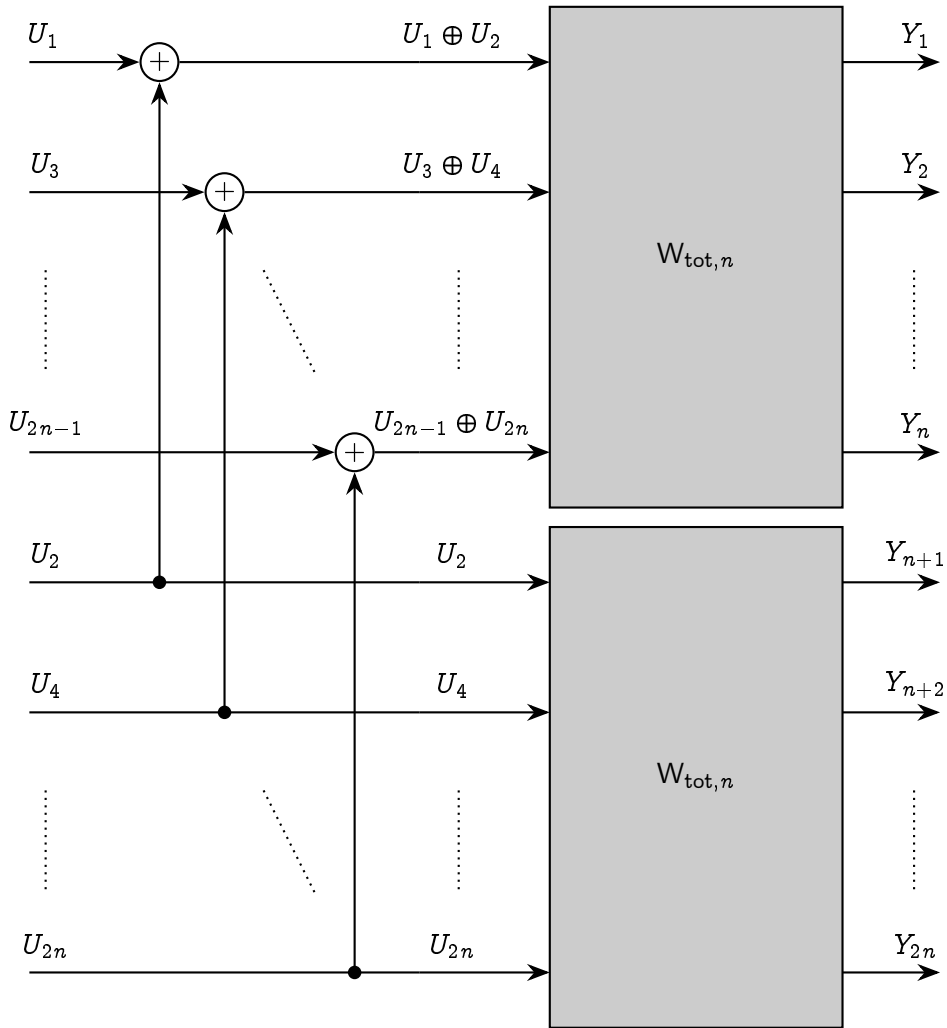

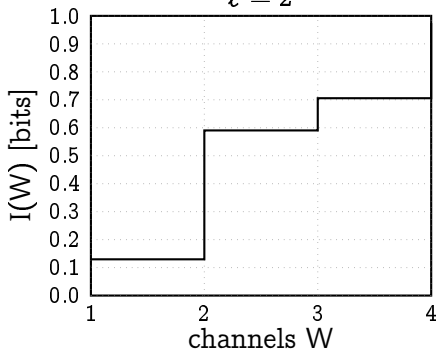
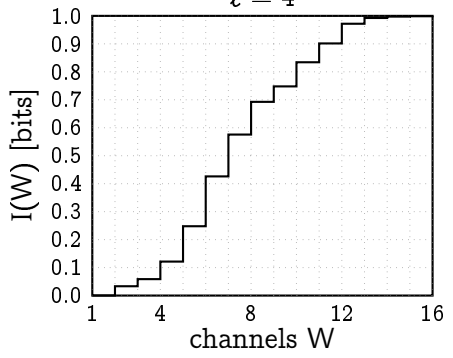
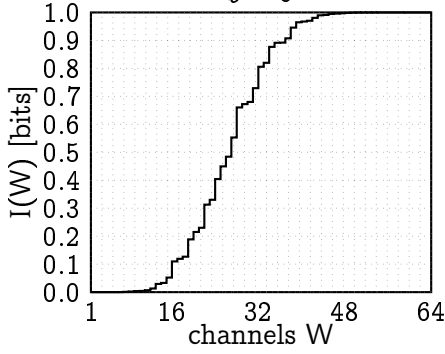
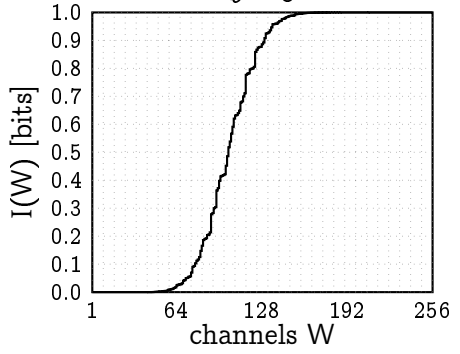
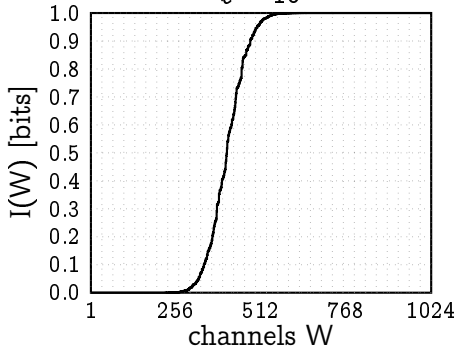
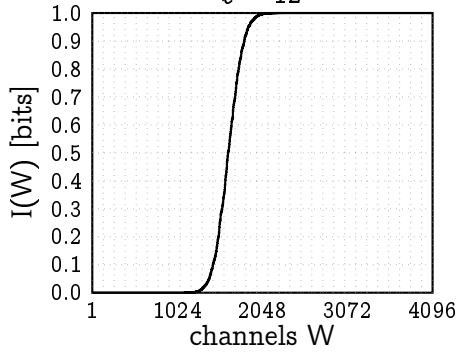
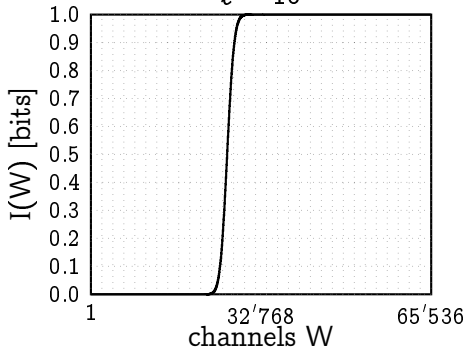
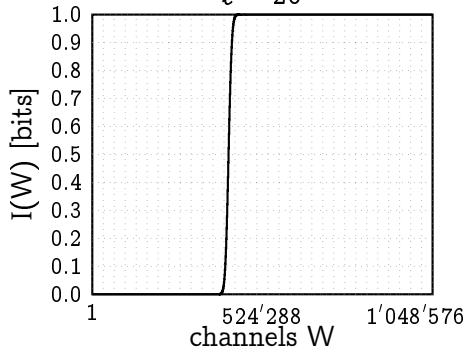

$\ell = 2$  $\ell = 4$  $\ell = 6$  $\ell = 8$  $\ell = 10$  $\ell = 12$  $\ell = 16$  $\ell = 20$ 

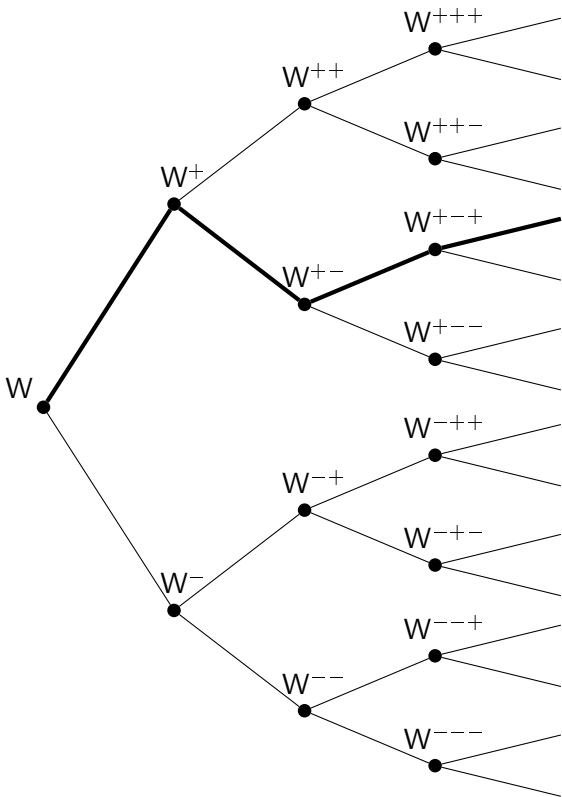

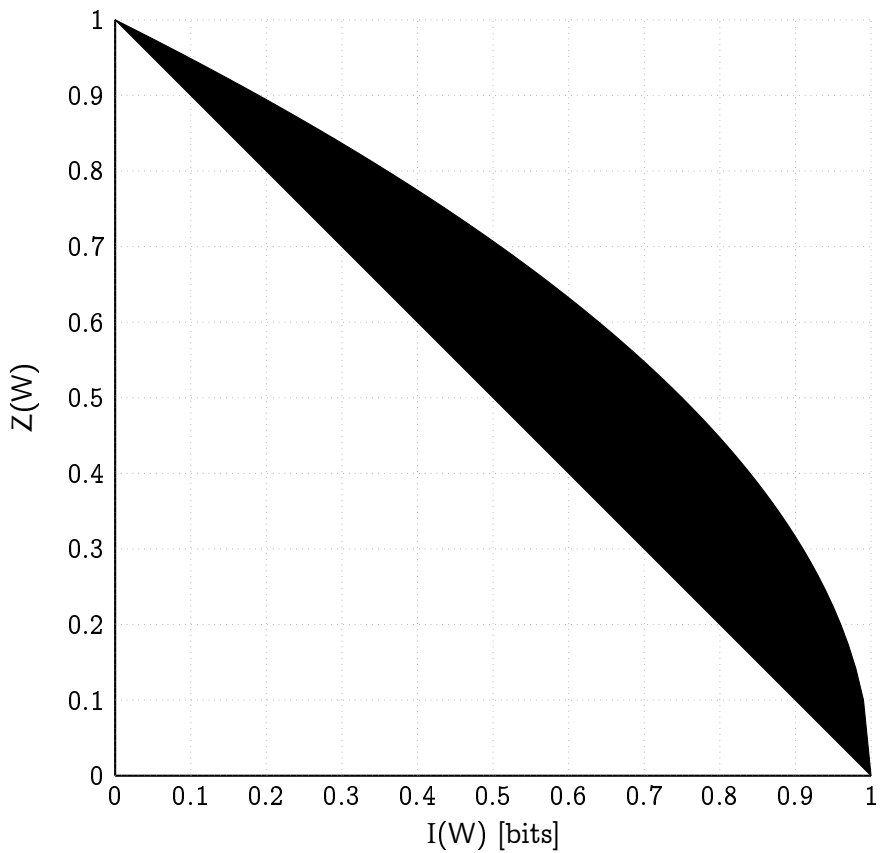

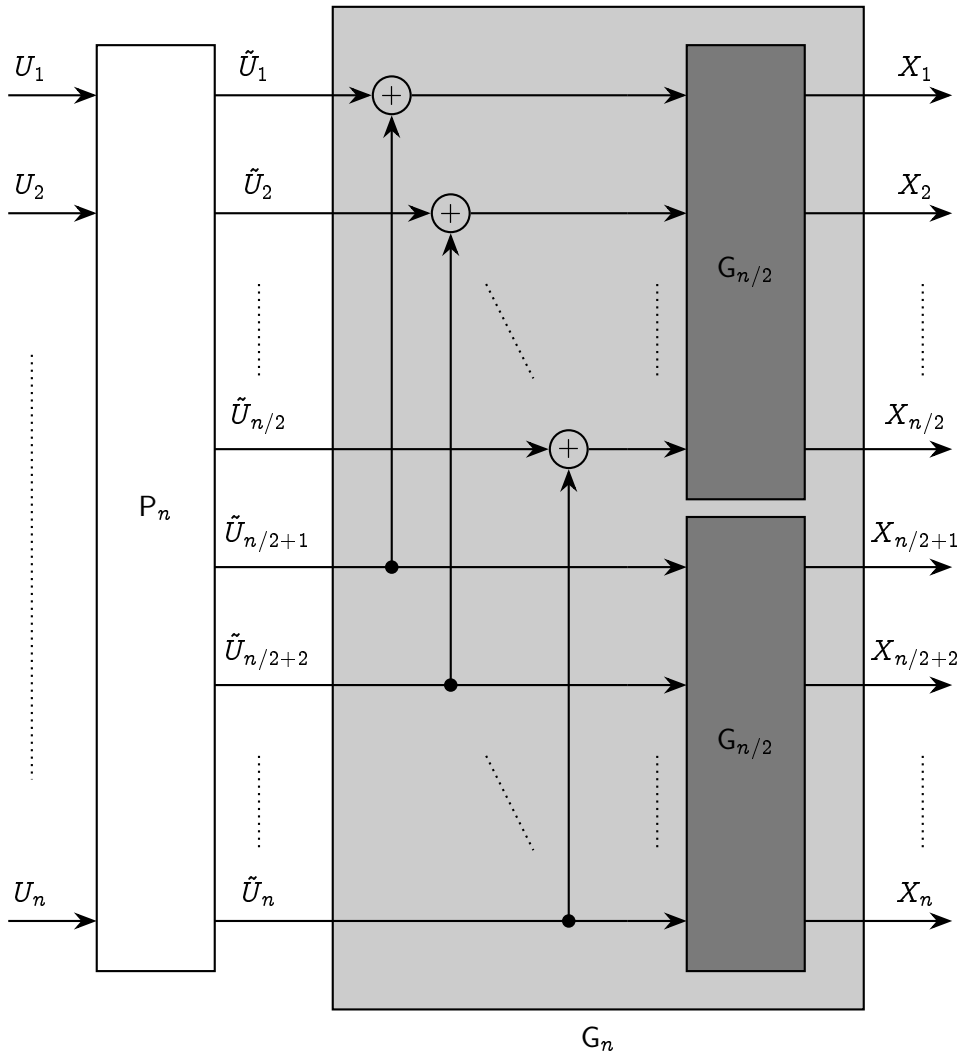

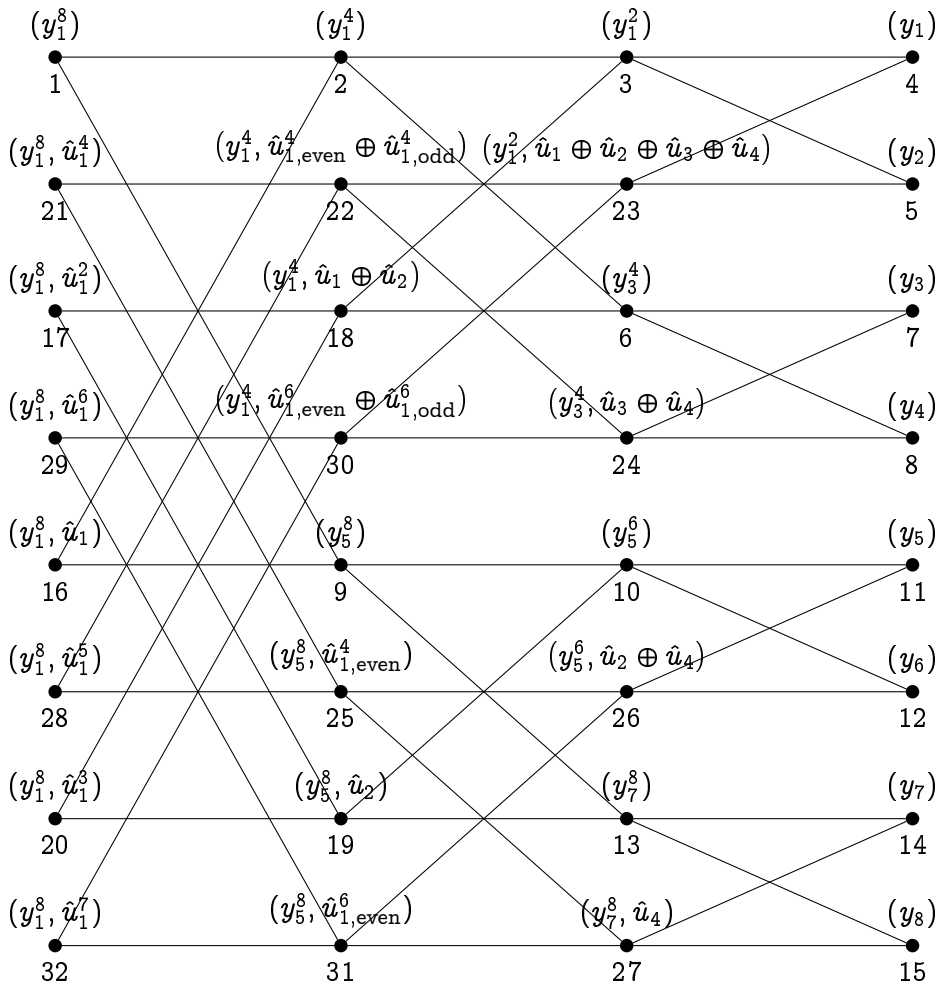



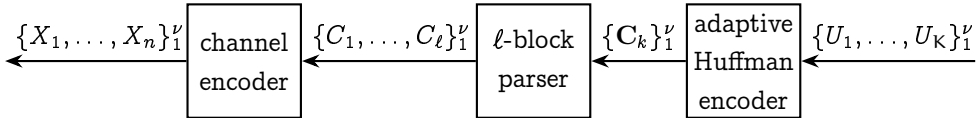

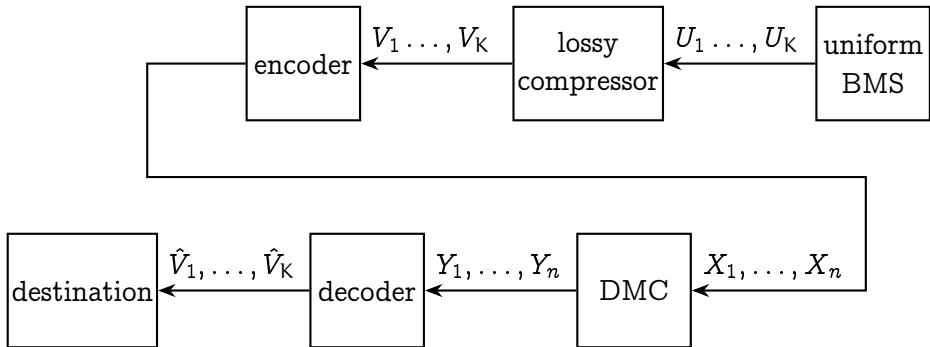



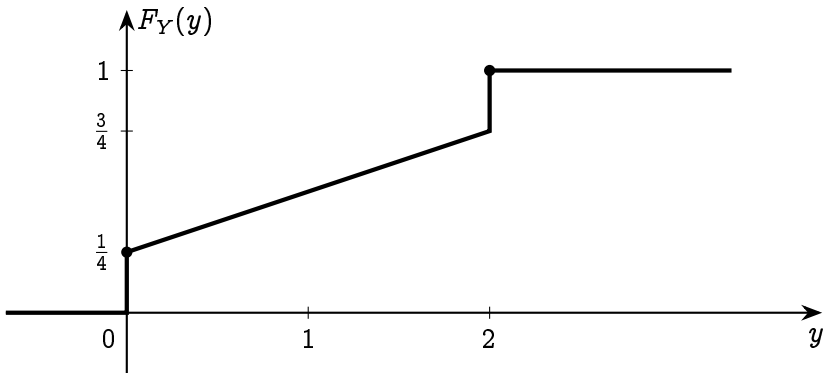

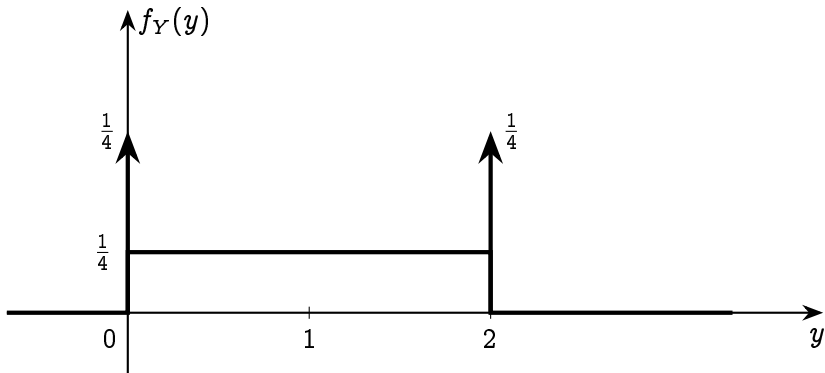

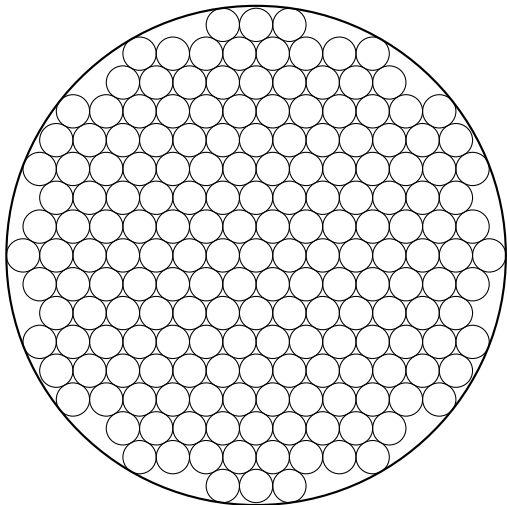

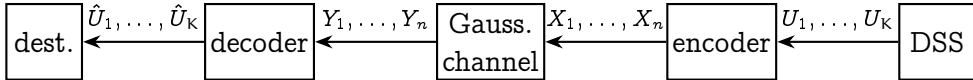

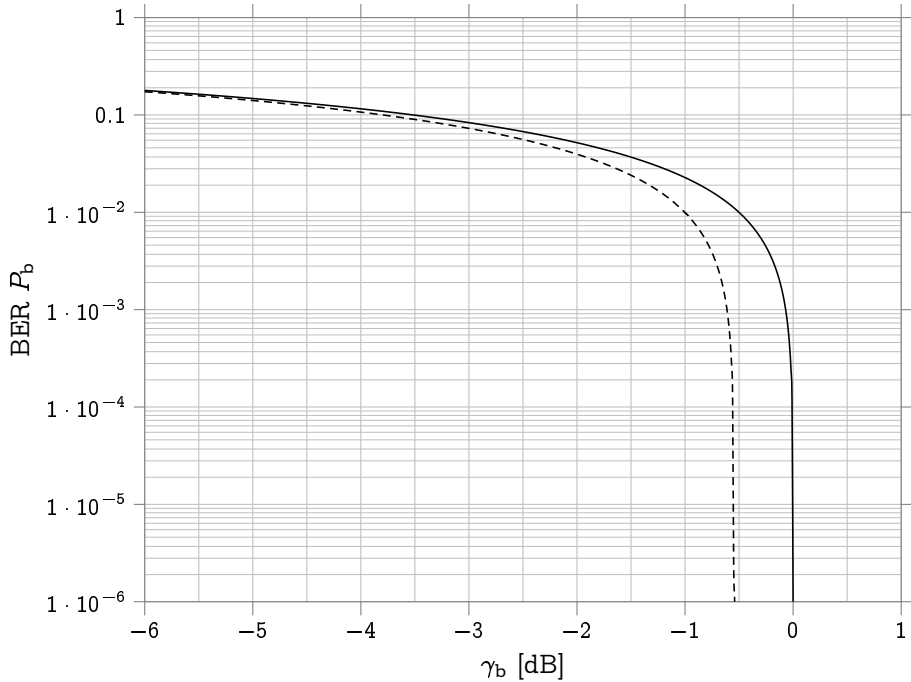

—  $R = 1/2$     - - -  $R = 1/3$

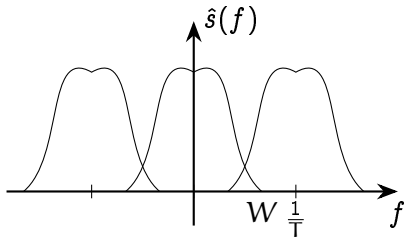
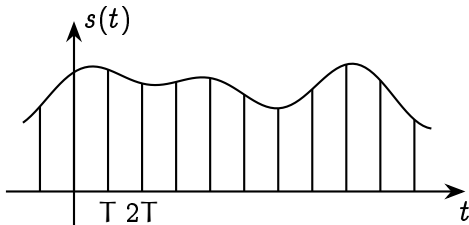

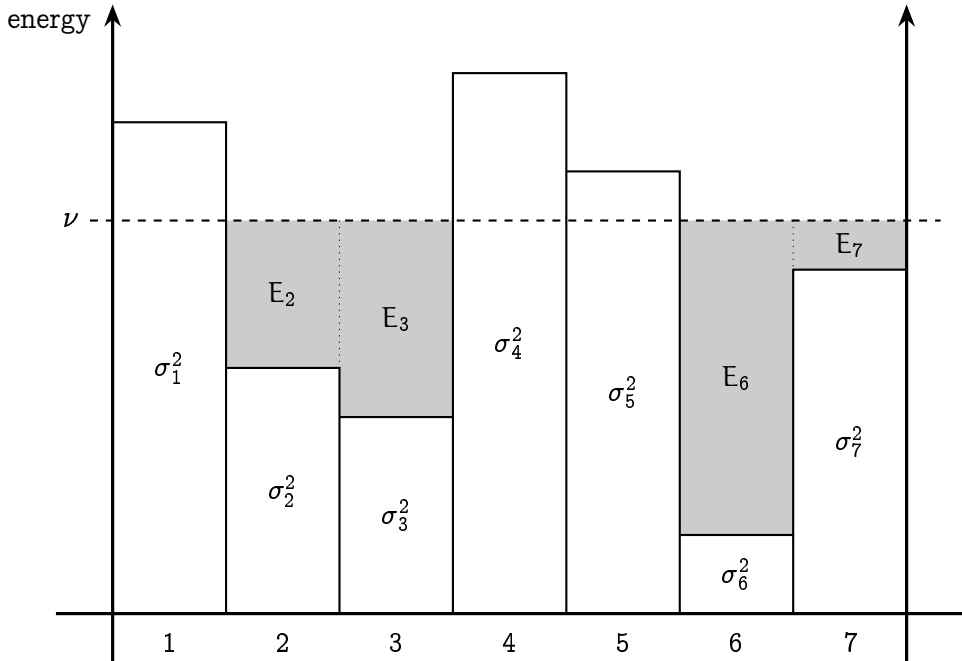

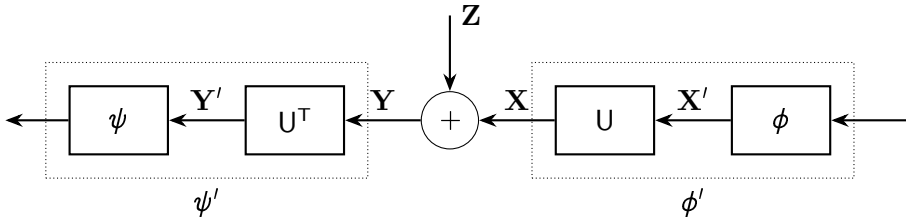



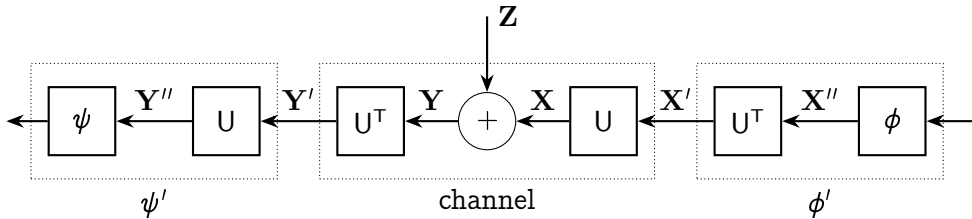

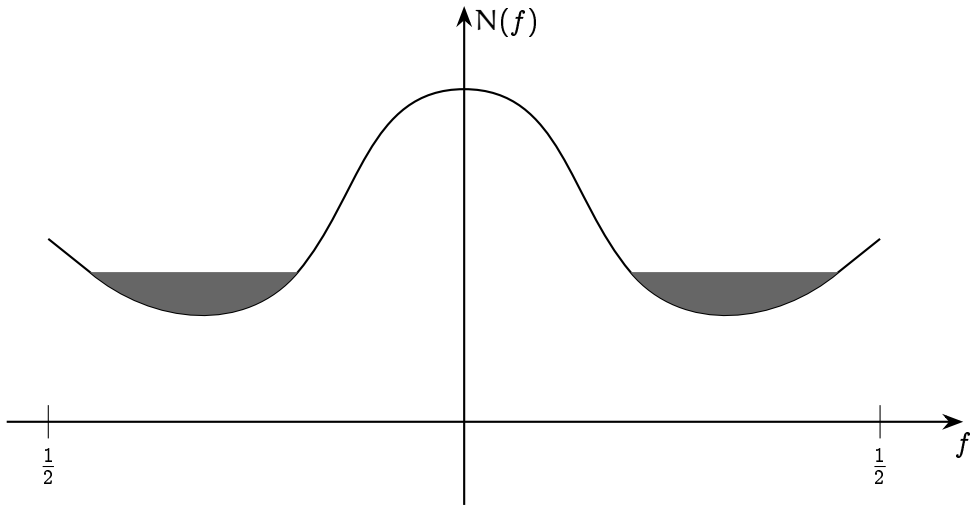

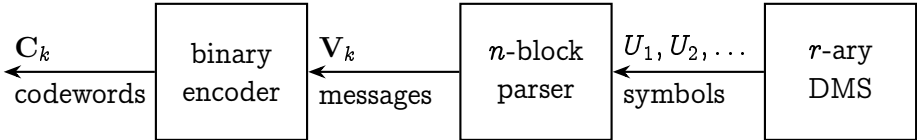

---

$P_{X,Y}$	$Y = 0$	$Y = 1$	$Y = 2$	$P_X$
$X = 0$	$\frac{1}{2}$	0	$\frac{1}{4}$	$\frac{3}{4}$
$X = 1$	0	$\frac{1}{4}$	0	$\frac{1}{4}$
$P_Y$	$\frac{1}{2}$	$\frac{1}{4}$	$\frac{1}{4}$	

---

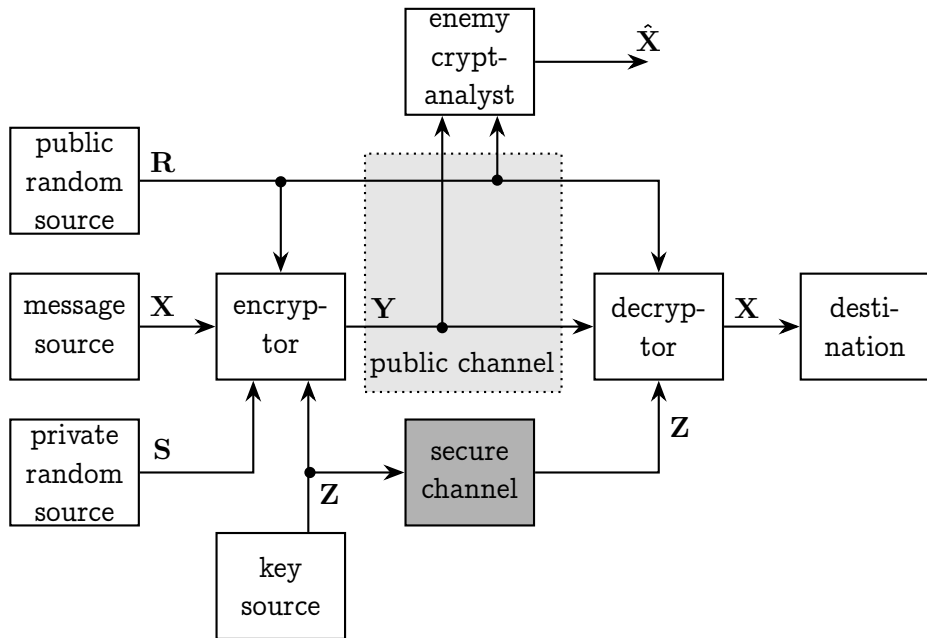

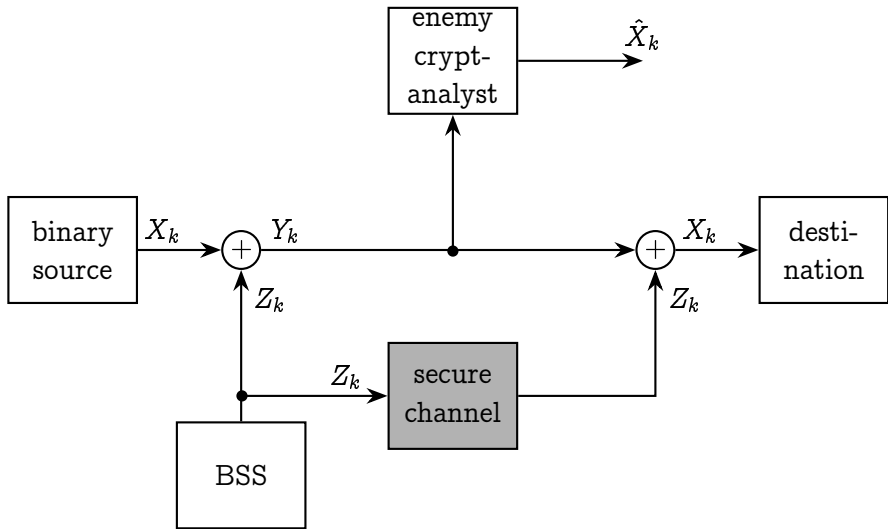

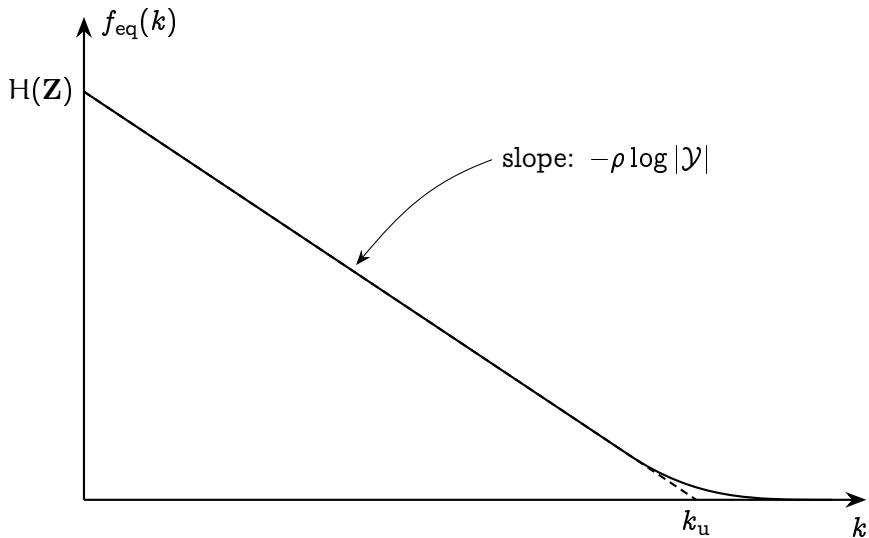

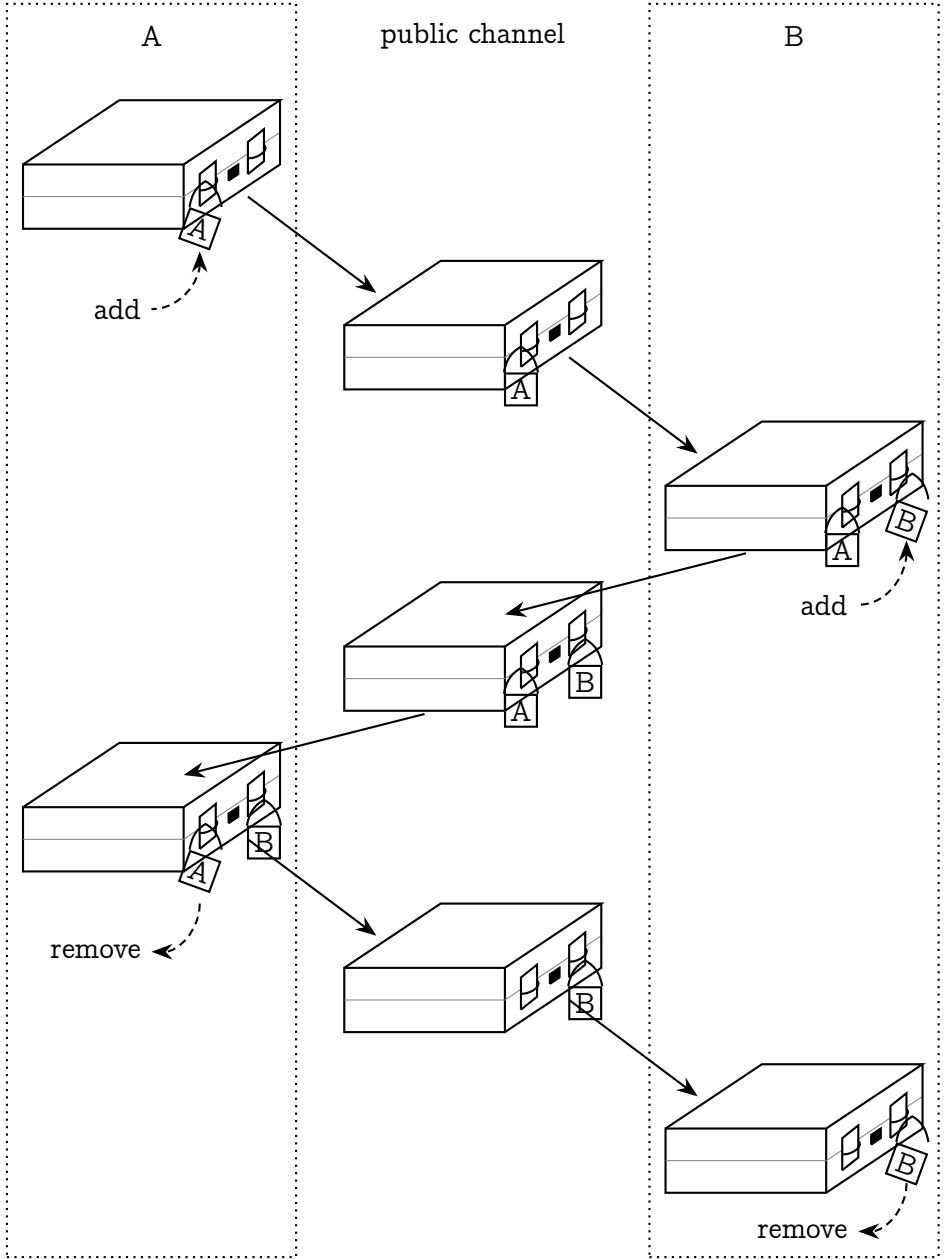



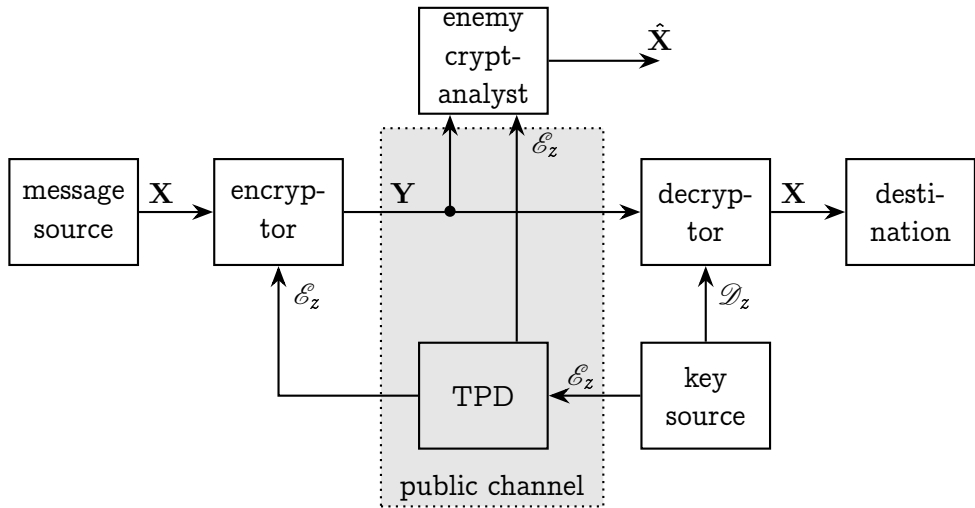

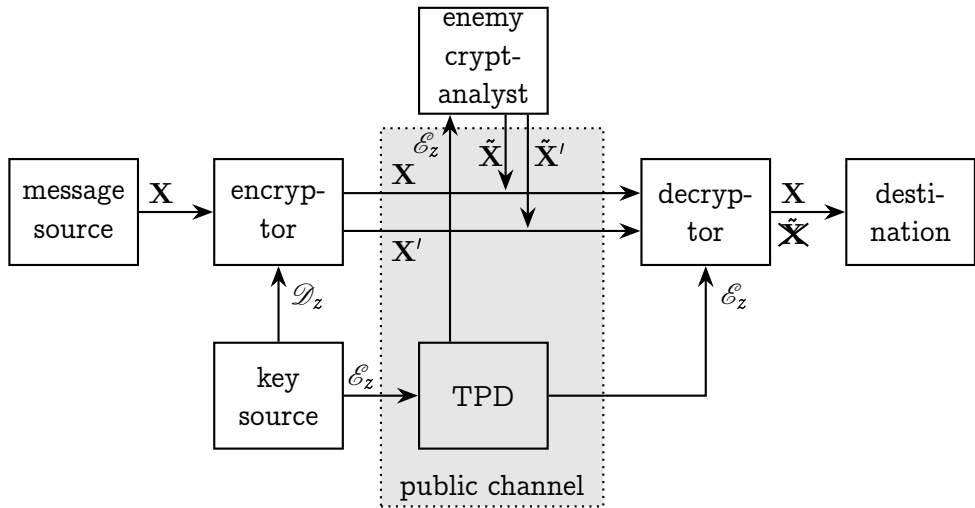

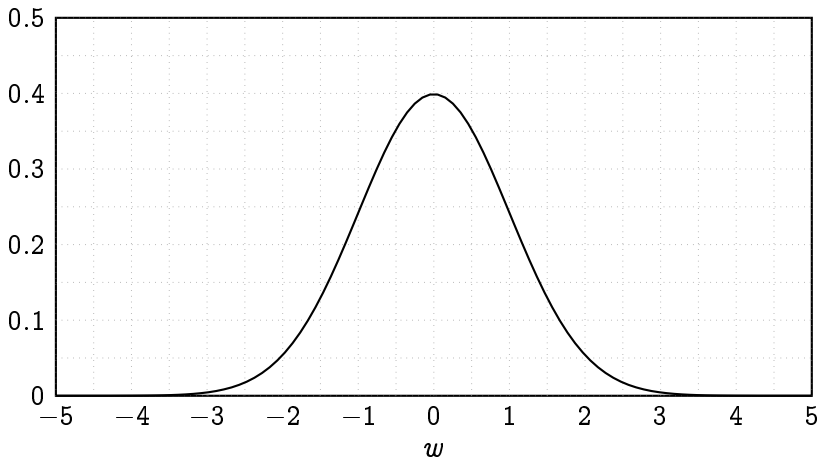

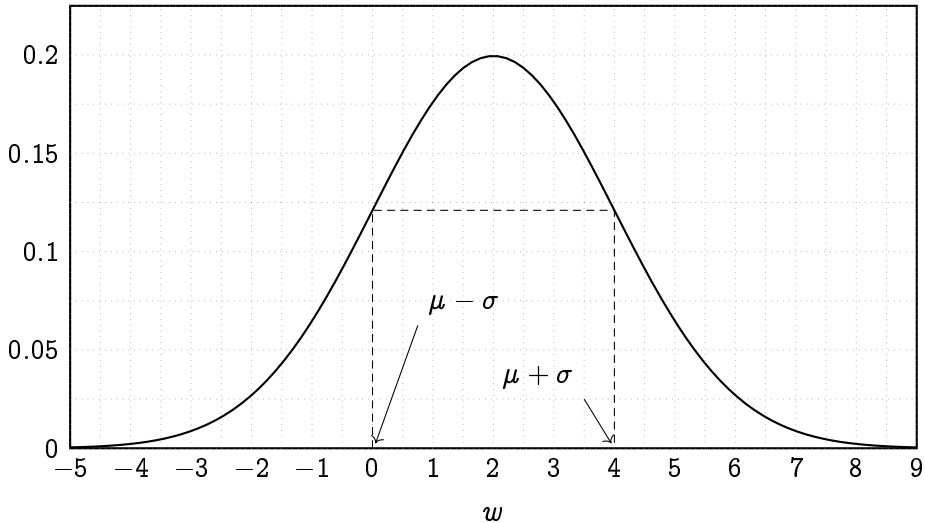

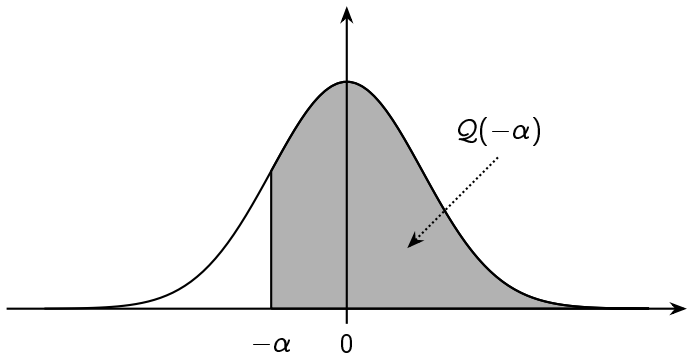
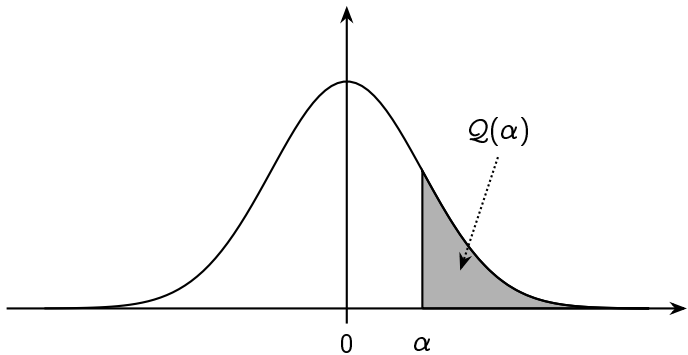

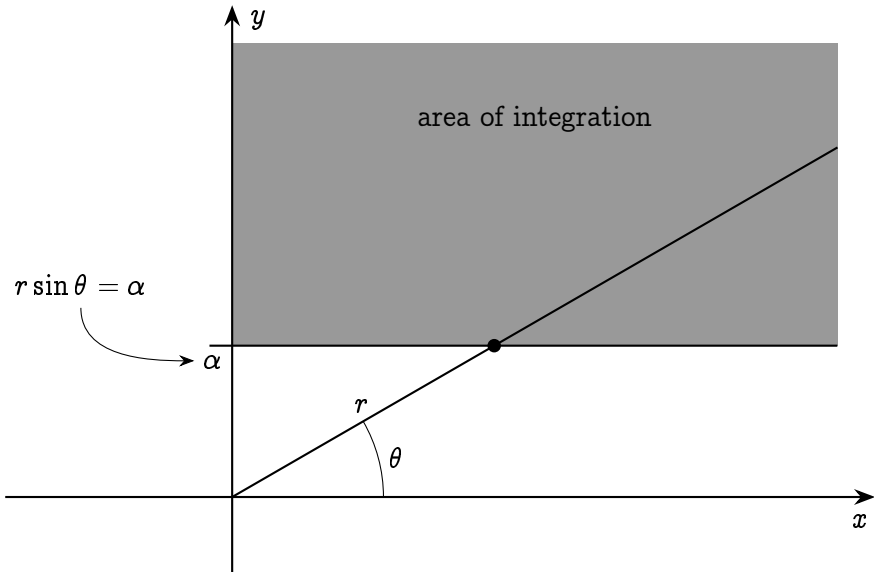

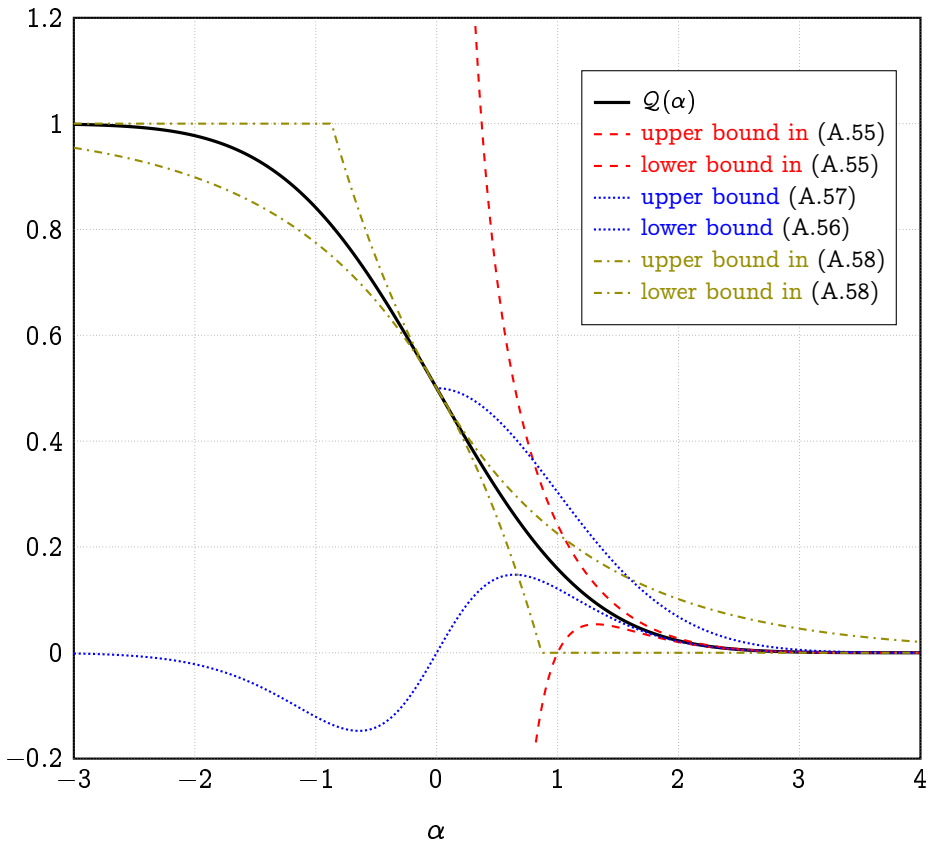

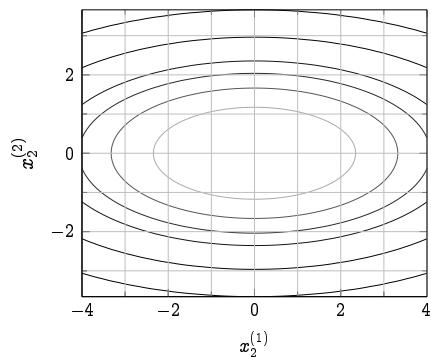
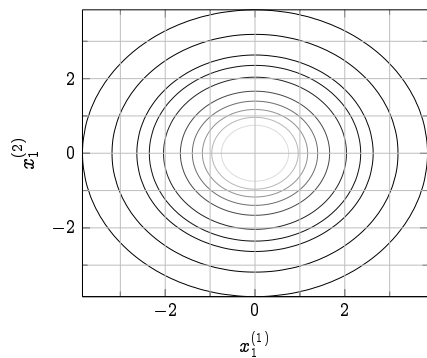
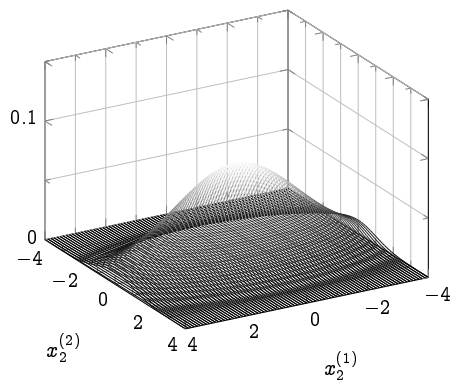
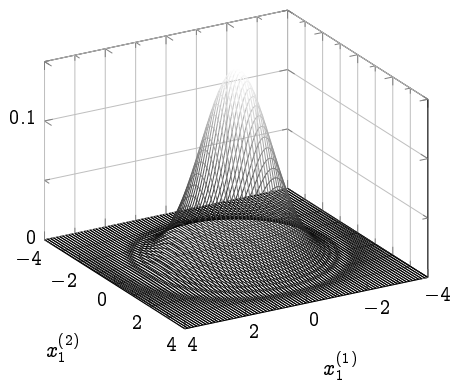



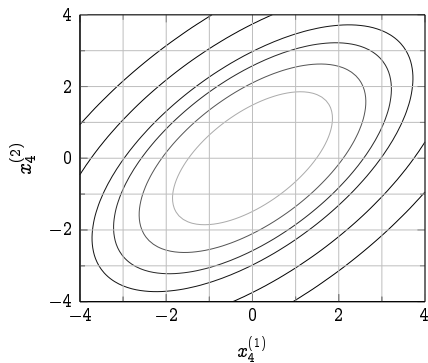
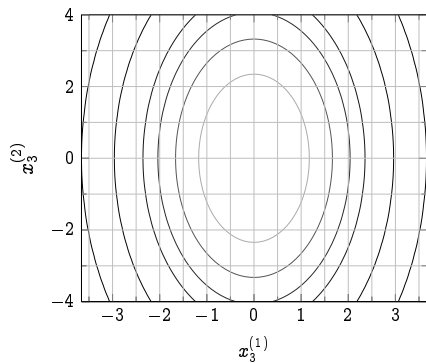
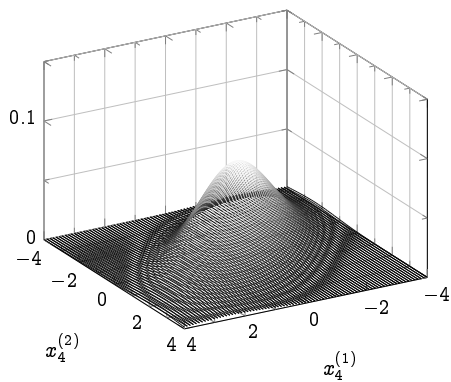
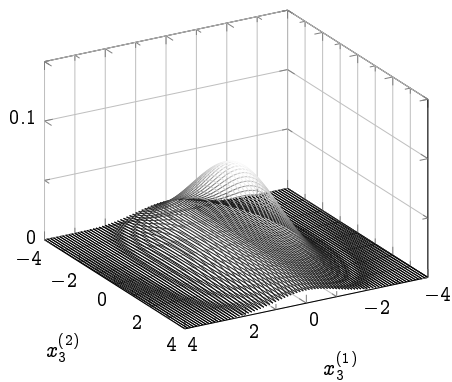

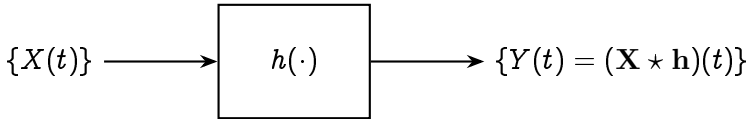

Stefan M. Moser, *Information Theory*, Version 6.15.